



MINISTÈRE
DE L'ÉDUCATION
NATIONALE
ET DE LA JEUNESSE

*Liberté
Égalité
Fraternité*

REPÈRES

CP 2024

Prénom de l'élève

Nom de l'élève

Classe de l'élève

SÉQUENCE 1

FRANÇAIS

Exercise 1

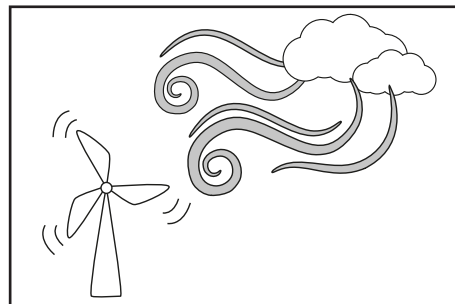
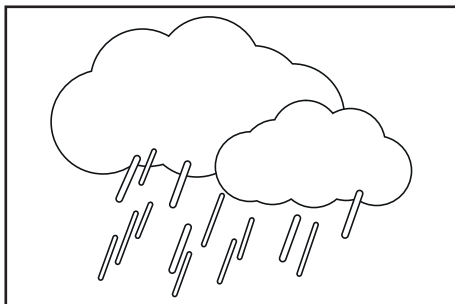
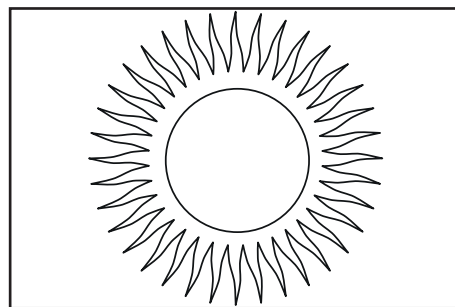
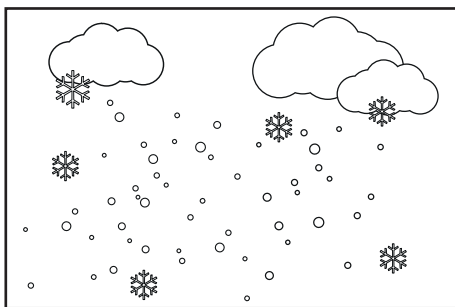
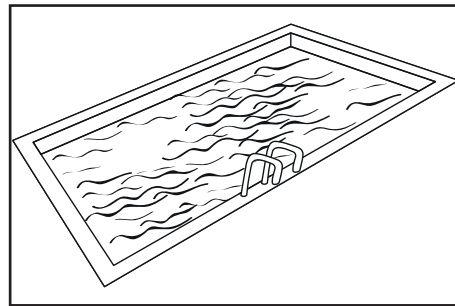
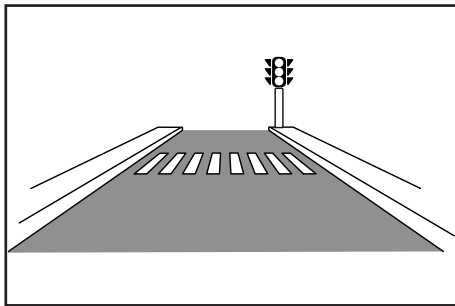
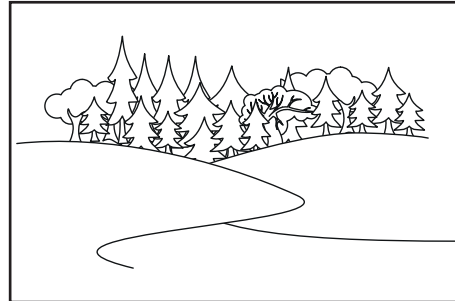
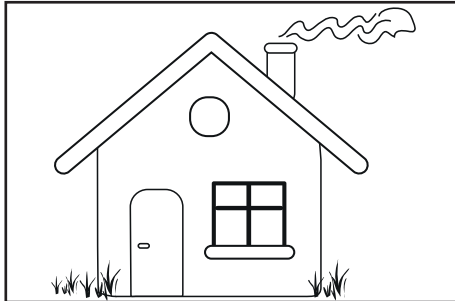

Exercice 1 (suite)

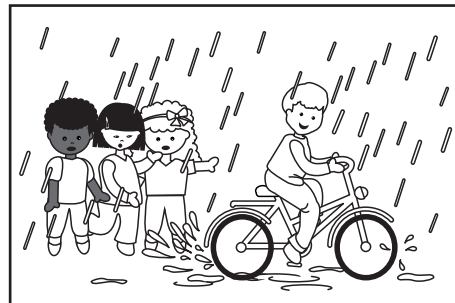
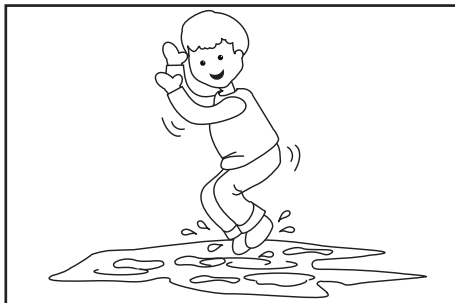
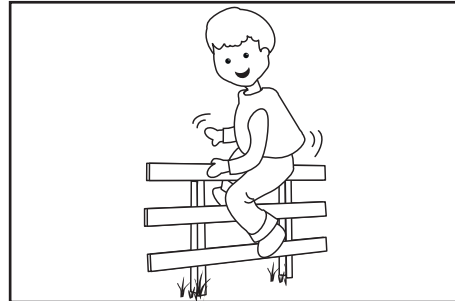
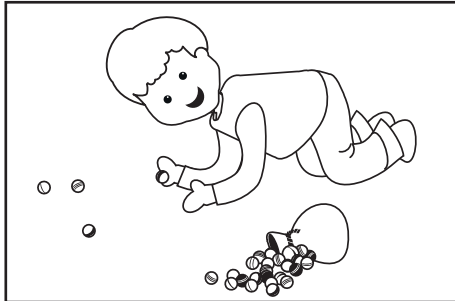

Exercise 2



l f a e G d

f O A i D g

o i F g a d



E b a e C d

b O A e D c

o e B c a d

Exercice 2 (suite)



E b a e C d

b O A e D c

o e B c a d



E b a e C d

b O A e D c

o e B c a d

Exercice 2 (suite)



E b a e C d

b O A e D c

o e B c a d



E b a e C d

b O A e D c

o e B c a d

Exercice 2 (suite)



E b a a C d

b O A e D c

o e B c a d



R v m n S d

v N M n D b

n r V s m d

Exercise 3

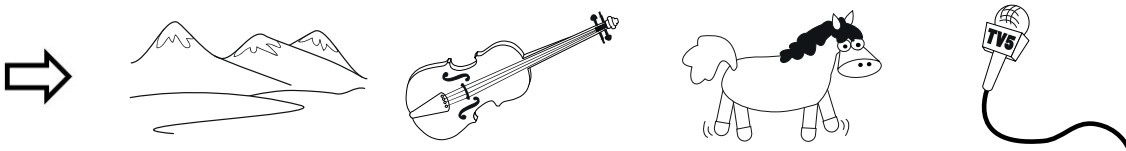
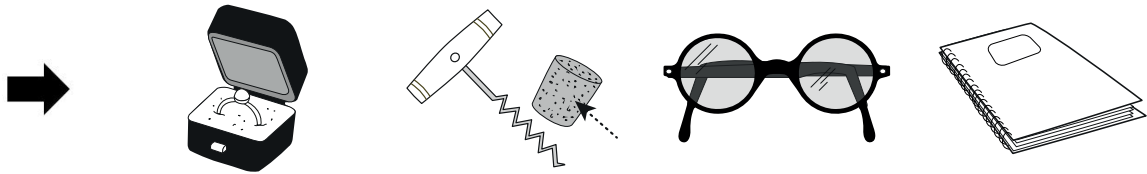
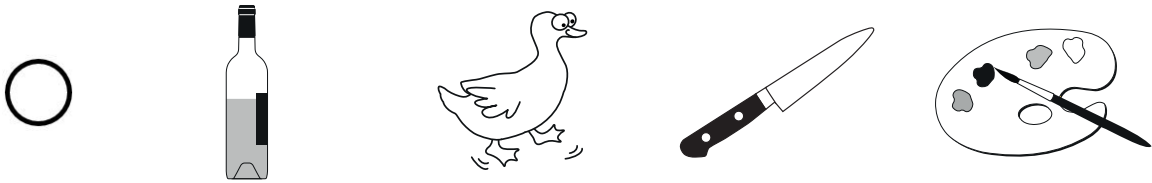
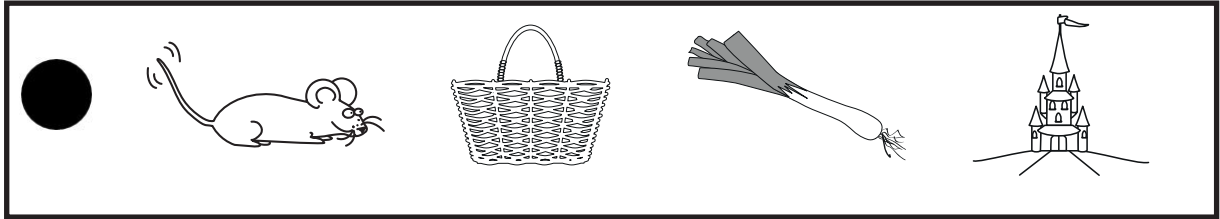

Exercice 3 (suite)

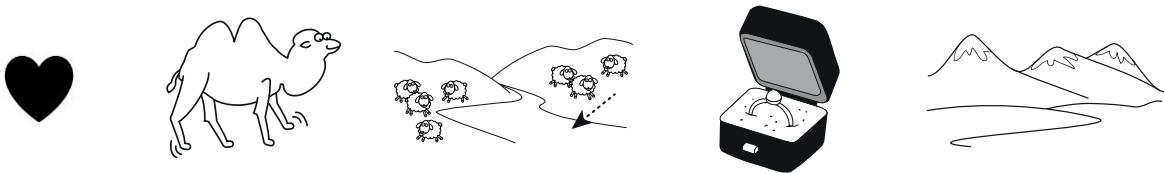
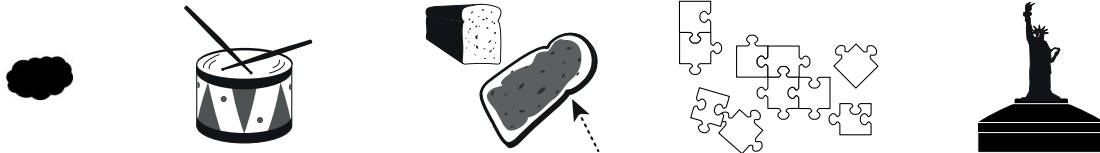

Exercise 4

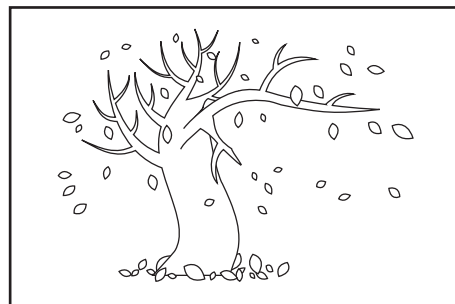
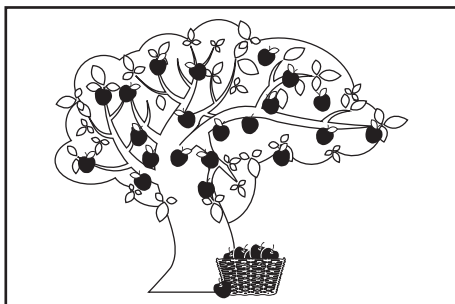
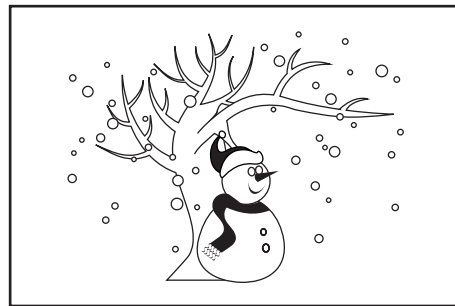
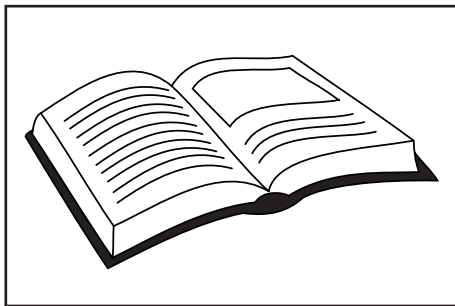
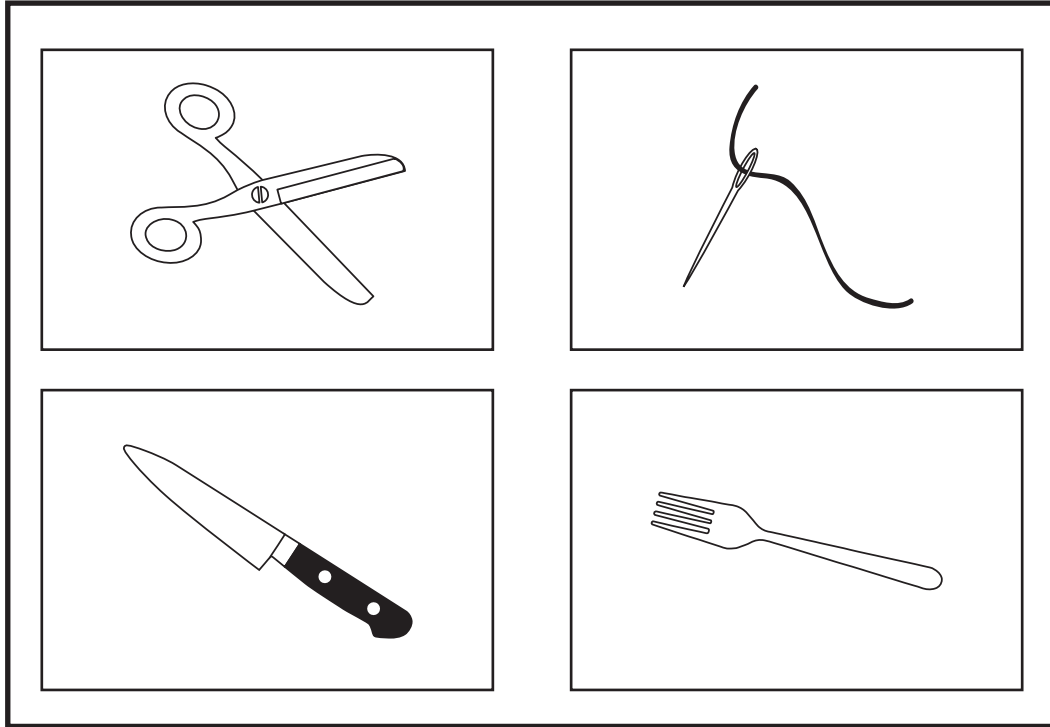

Exercice 4 (suite)

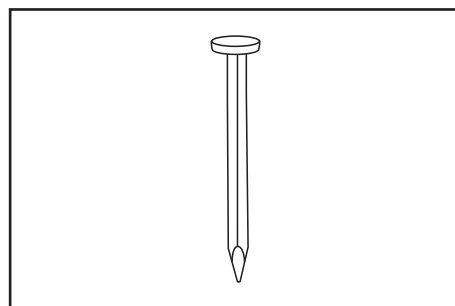
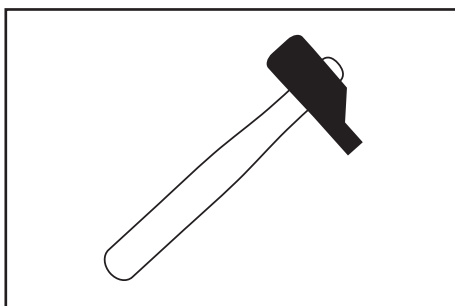
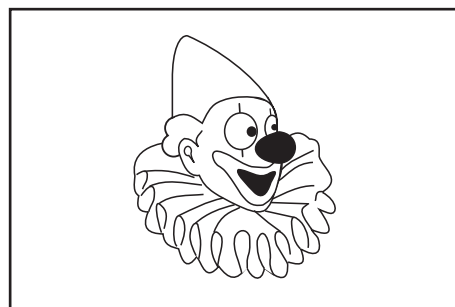
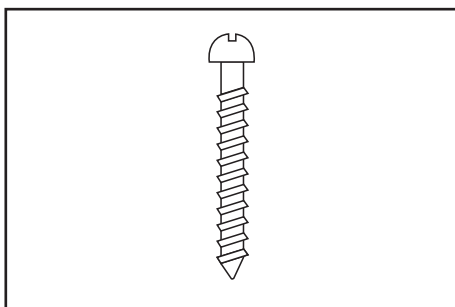
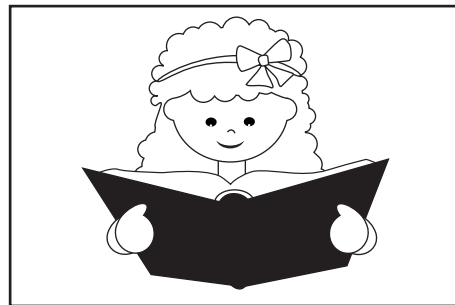
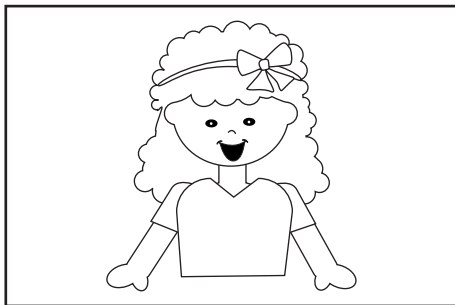
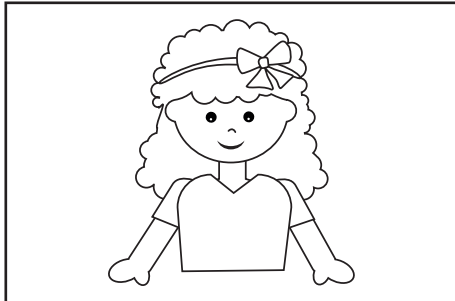

Exercice 4 (suite)

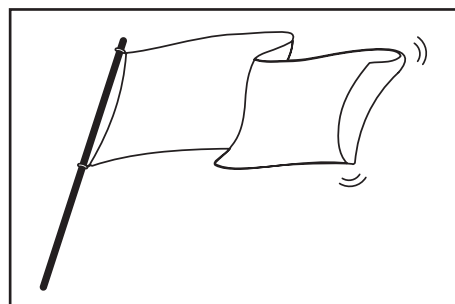
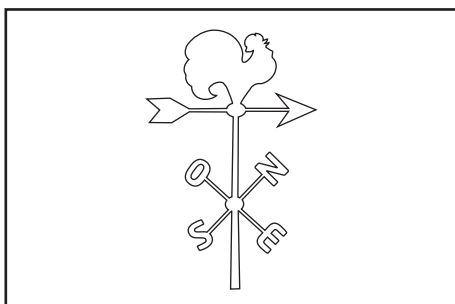
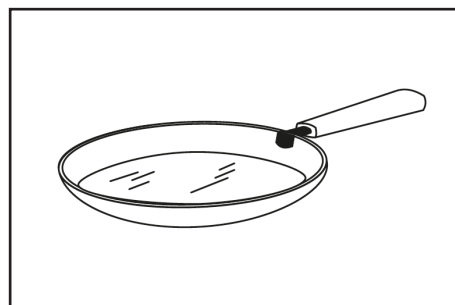
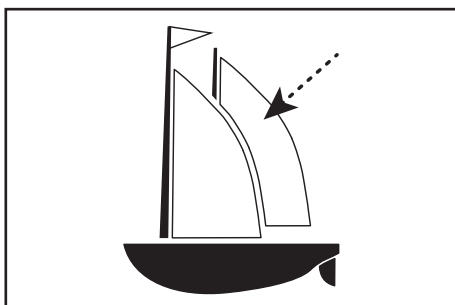
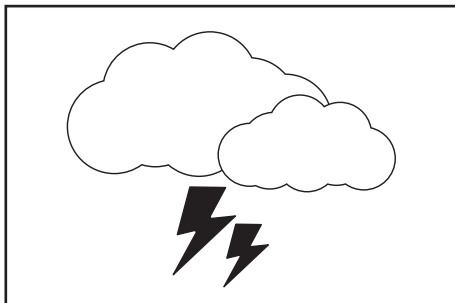
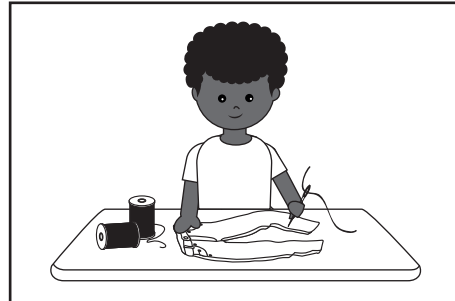
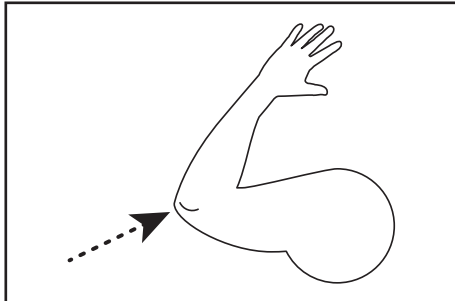

Exercice 4 (suite)

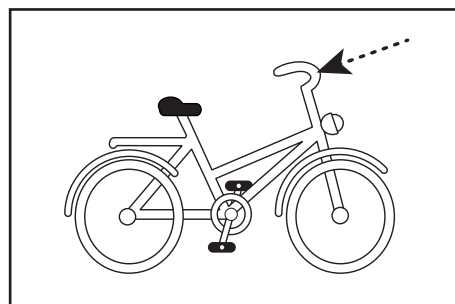
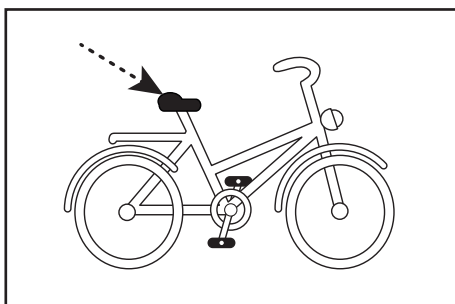
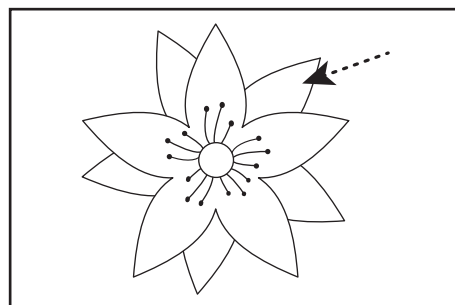
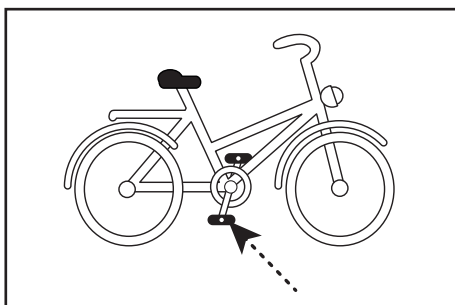
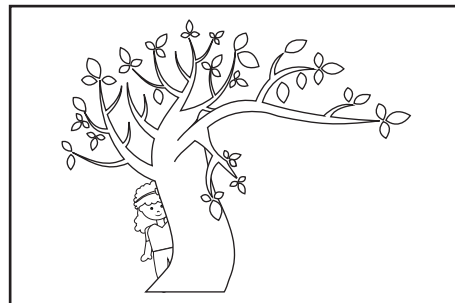
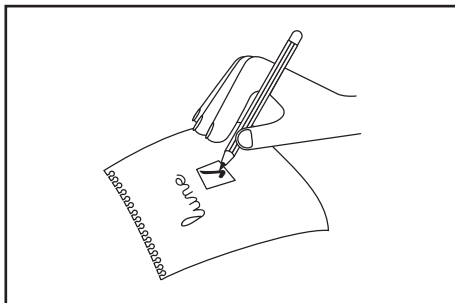
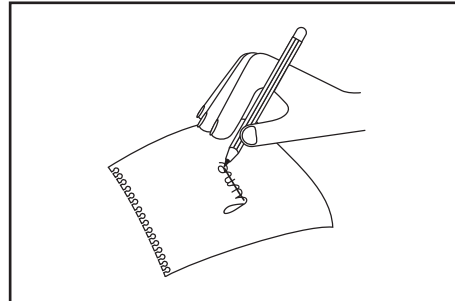
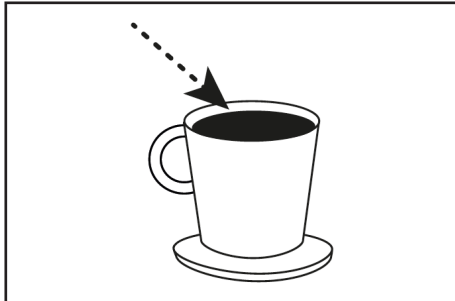

Exercice 4 (suite)

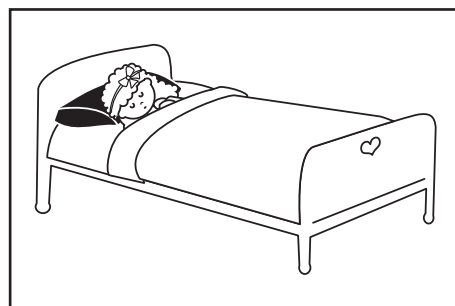
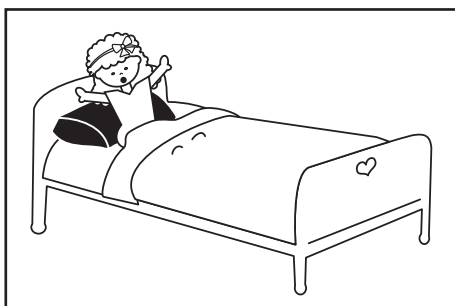
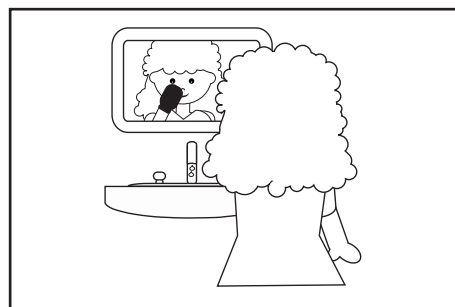
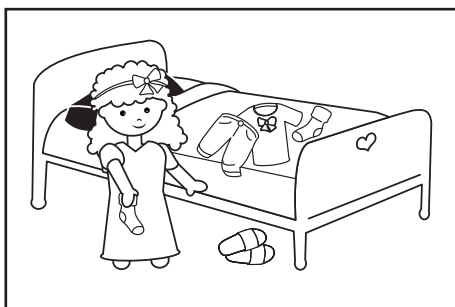
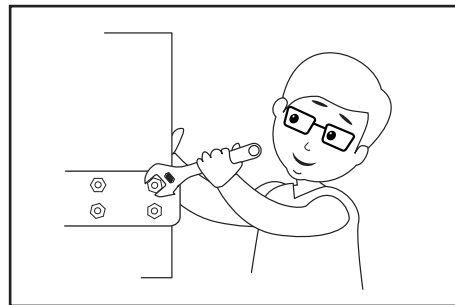
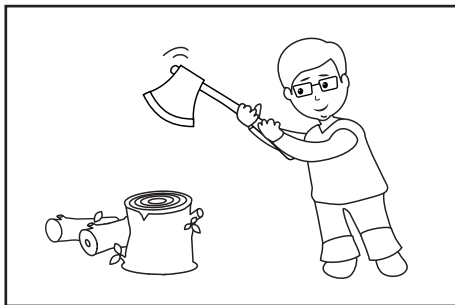
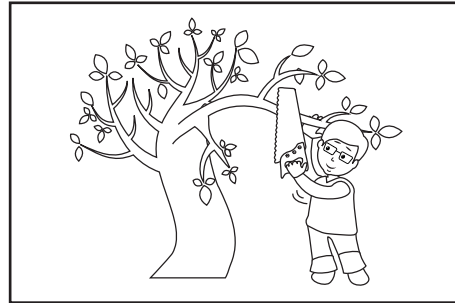
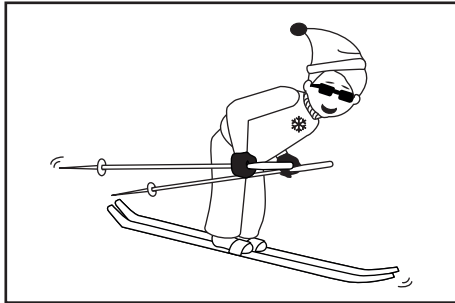

Exercice 4 (suite)

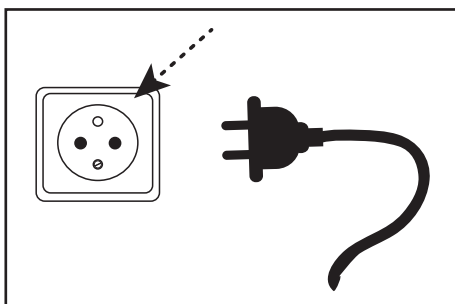
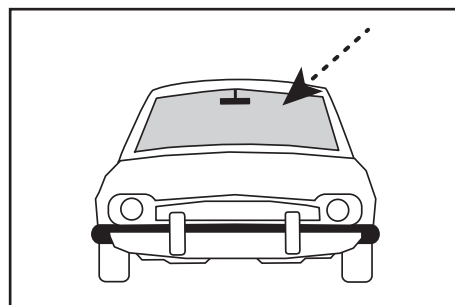
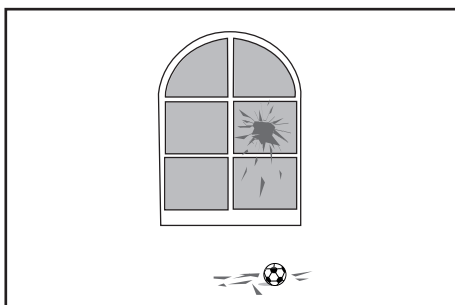
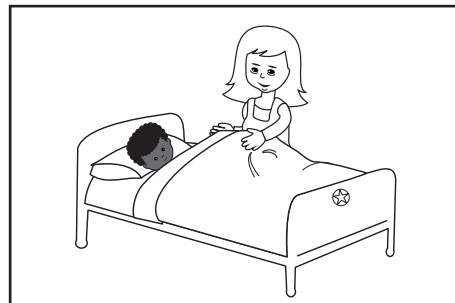
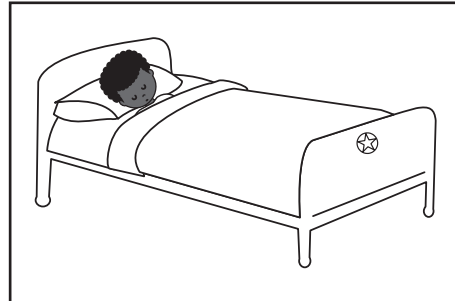
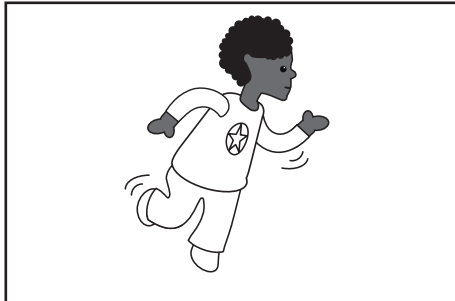

Exercice 4 (suite)

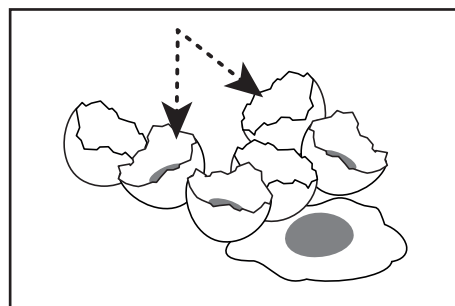
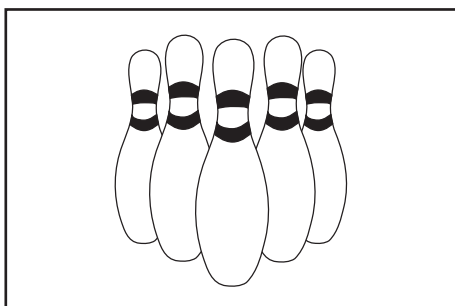
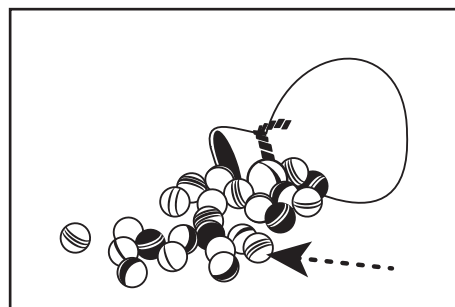
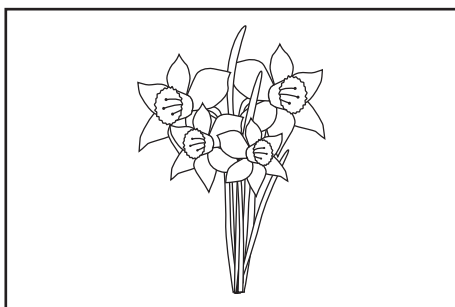
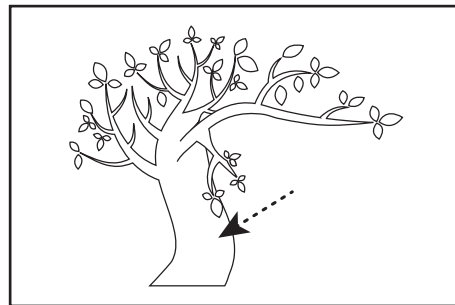
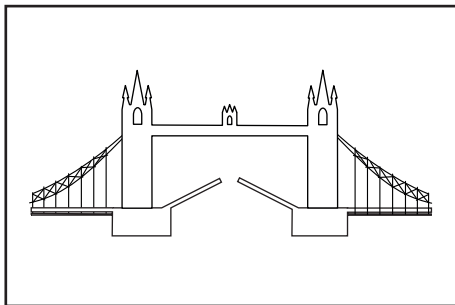
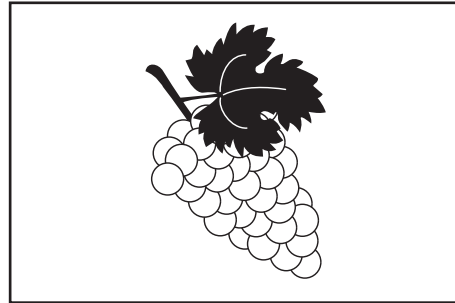
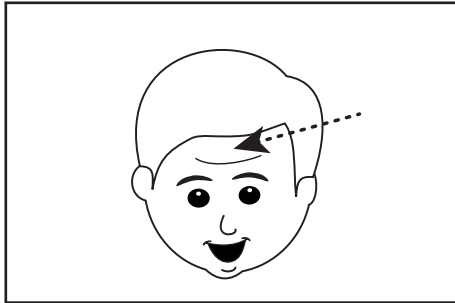

Exercice 4 (suite)

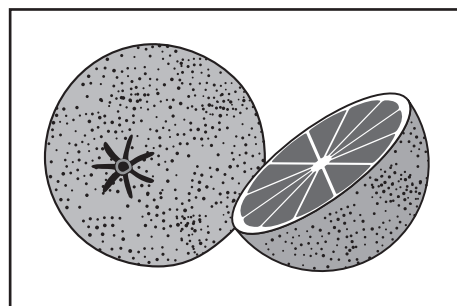
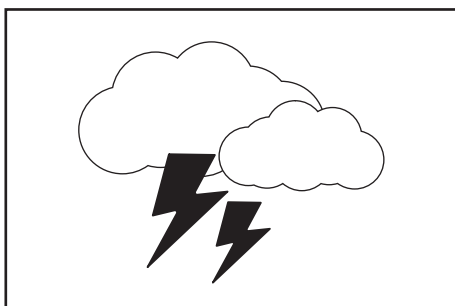
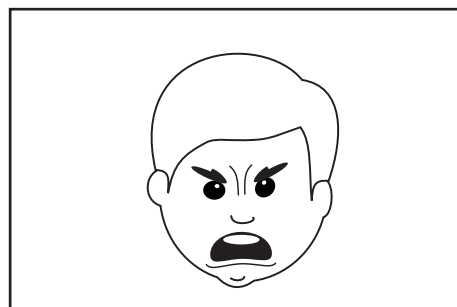
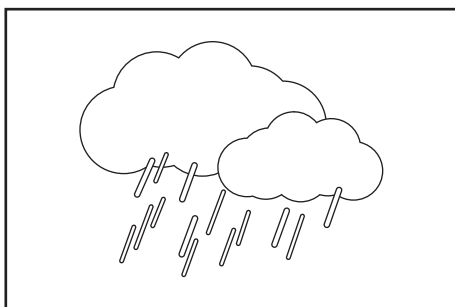
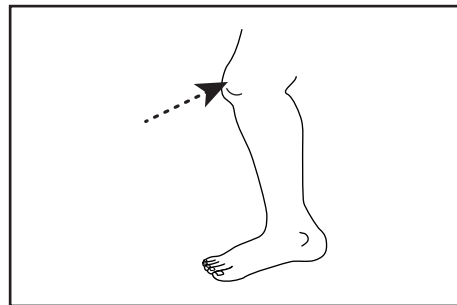
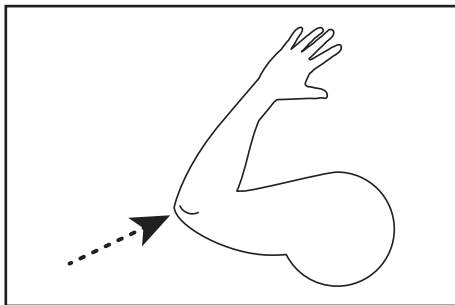
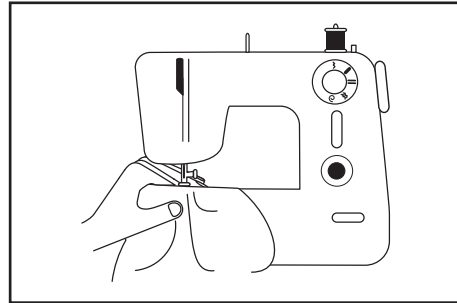
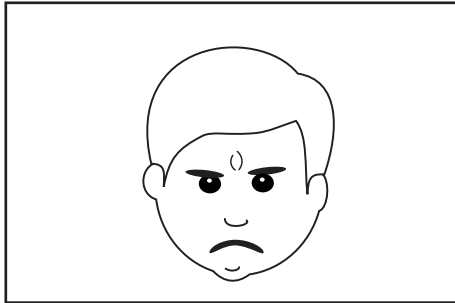

SÉQUENCE 2

MATHÉMATIQUES

Exercise 5

<input checked="" type="radio"/>	2	10	7	1	9	6
----------------------------------	---	----	---	---	---	---

<input type="radio"/>	0	6	3	2	5	1
-----------------------	---	---	---	---	---	---

<input type="checkbox"/>	7	4	1	3	5	2
--------------------------	---	---	---	---	---	---

<input type="checkbox"/>	2	8	6	0	10	9
--------------------------	---	---	---	---	----	---

<input type="checkbox"/>	1	10	0	6	8	2
--------------------------	---	----	---	---	---	---

<input type="checkbox"/>	7	1	2	10	5	3
--------------------------	---	---	---	----	---	---

Exercice 5 (suite)

☛ 0 2 9 10 1 7

☁ 0 6 3 2 5 1

♥ 7 4 1 3 5 2

♡ 2 8 6 0 10 9

✖ 0 2 9 10 1 7

Exercise 6

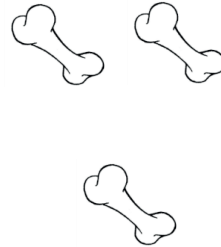
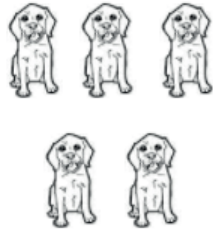

1

2

3



4

5

6

Exercice 6 (suite)

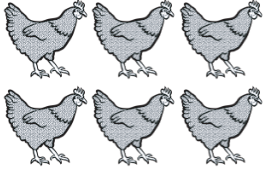

	
---	---

1

2



3

4

5

6

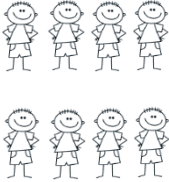

	
---	---

1

2

3

4

5

6

Exercice 6 (suite)

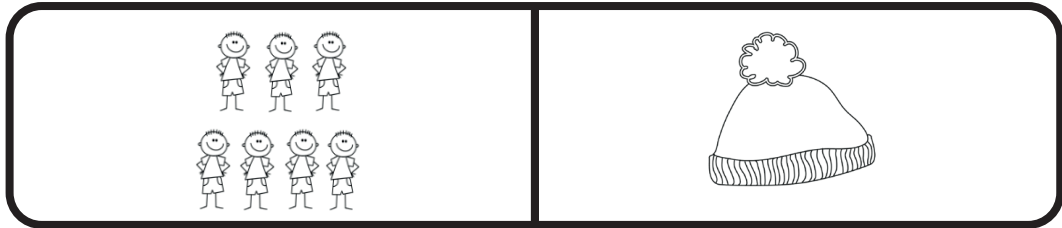

1

2

3

4

5

6

Exercise 7

●



1	2	3	4	5	6	7	8	9	10
---	---	---	---	---	---	---	---	---	----

○



1	2	3	4	5	6	7	8	9	10
---	---	---	---	---	---	---	---	---	----

➔



1	2	3	4	5	6	7	8	9	10
---	---	---	---	---	---	---	---	---	----

Exercice 7 (suite)



1	2	3	4	5	6	7	8	9	10
---	---	---	---	---	---	---	---	---	----



1	2	3	4	5	6	7	8	9	10
---	---	---	---	---	---	---	---	---	----



1	2	3	4	5	6	7	8	9	10
---	---	---	---	---	---	---	---	---	----

Exercice 7 (suite)



1	2	3	4	5	6	7	8	9	10
---	---	---	---	---	---	---	---	---	----



1	2	3	4	5	6	7	8	9	10
---	---	---	---	---	---	---	---	---	----



1	2	3	4	5	6	7	8	9	10
---	---	---	---	---	---	---	---	---	----

Exercise 8

Exemples

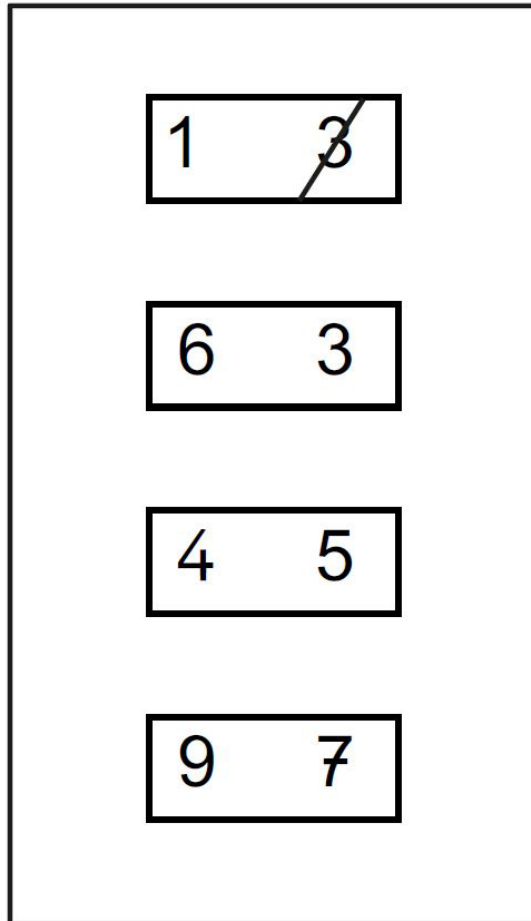

Exercice 8 (suite)

8	9	7	4	5	6	4	1
2	6	5	9	4	3	9	6
5	4	7	6	2	1	5	8
3	2	5	1	9	8	3	4
4	1	8	9	4	5	2	6
2	5	1	4	8	7	5	1
3	6	8	5	2	3	9	8
8	4	1	2	6	7	5	4
6	7	4	3	9	5	1	2
2	1	5	6	4	8	7	6

Exercise 9

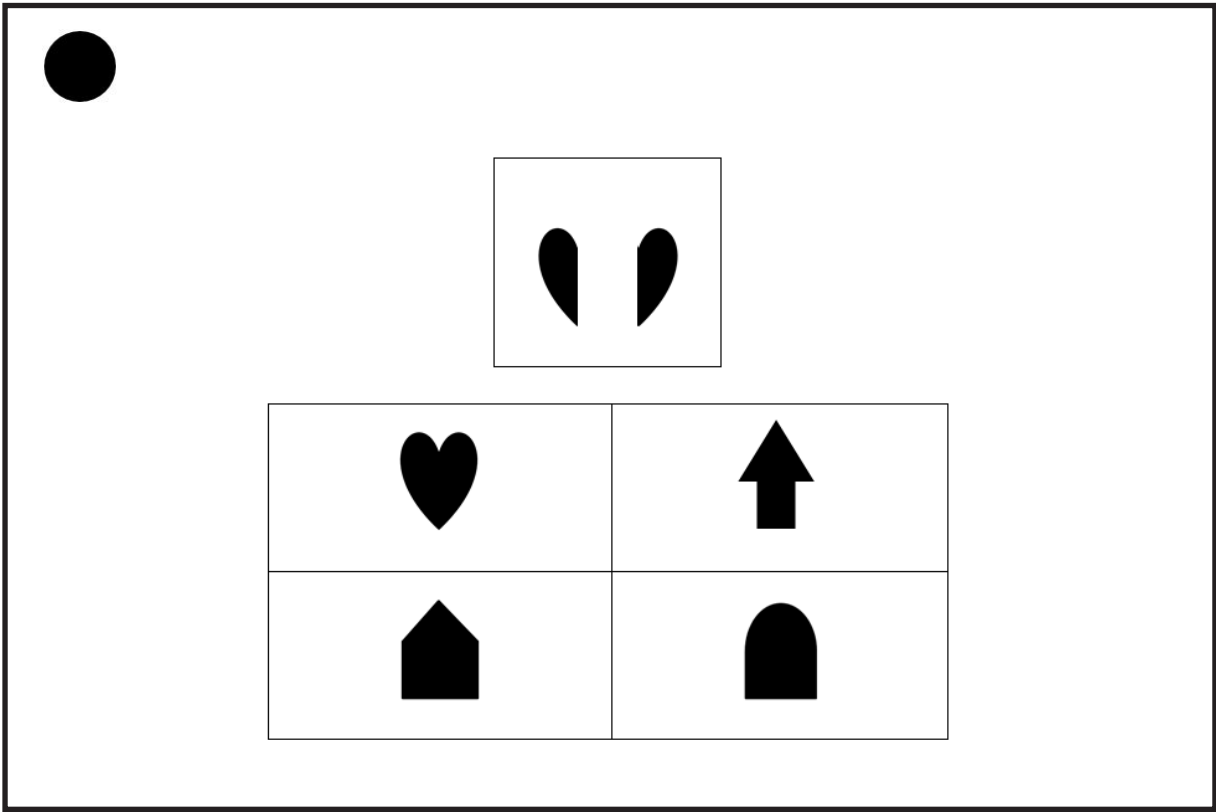

Exercice 9 (suite)

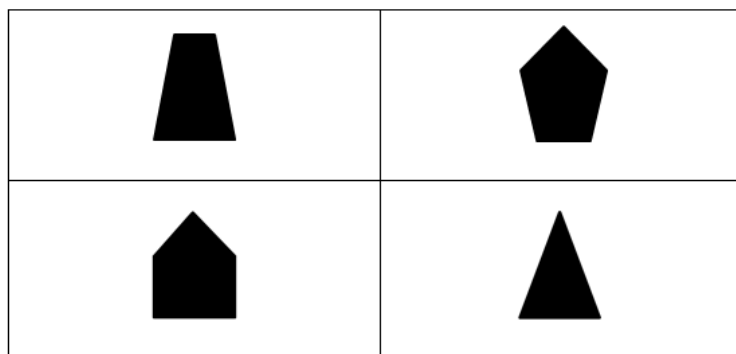
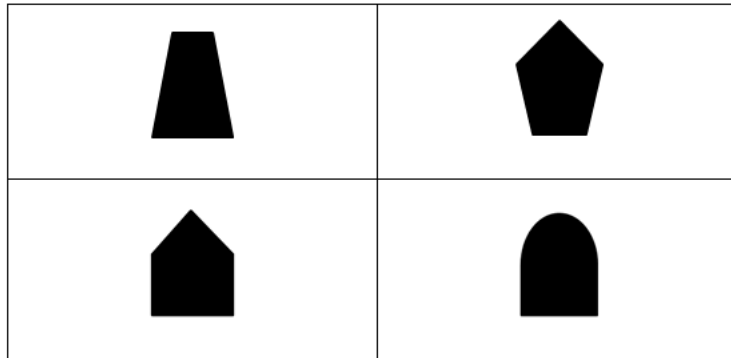
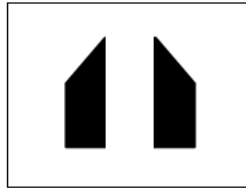

Exercice 9 (suite)

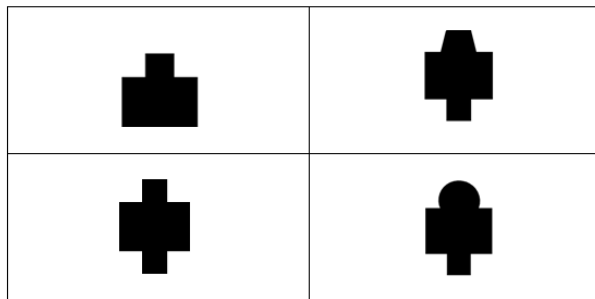
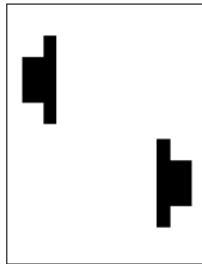
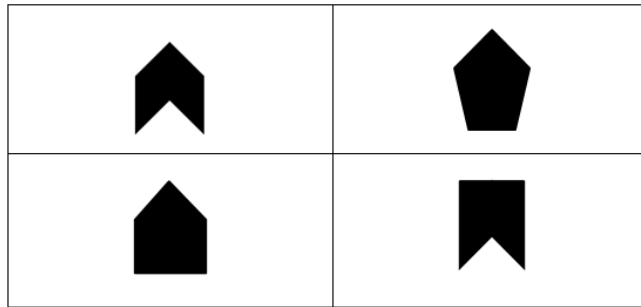
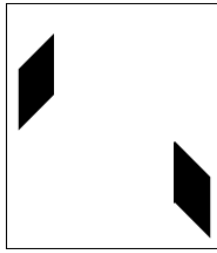

Exercice 9 (suite)

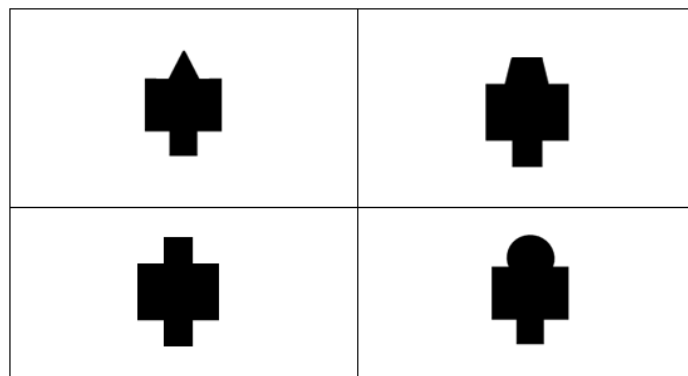
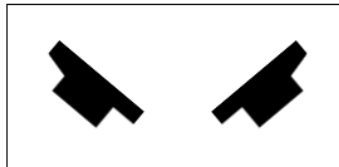
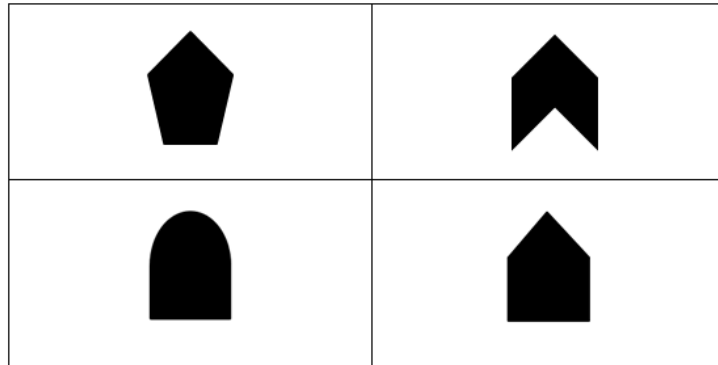
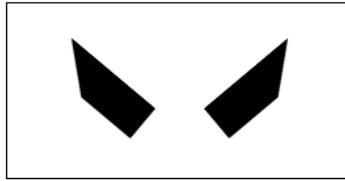

Exercice 9 (suite)

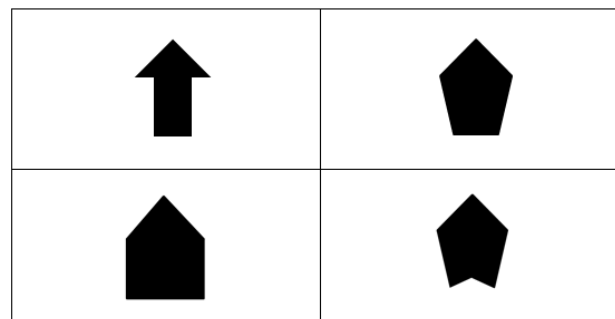
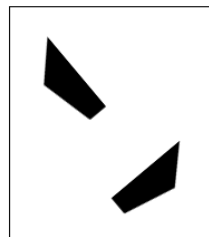
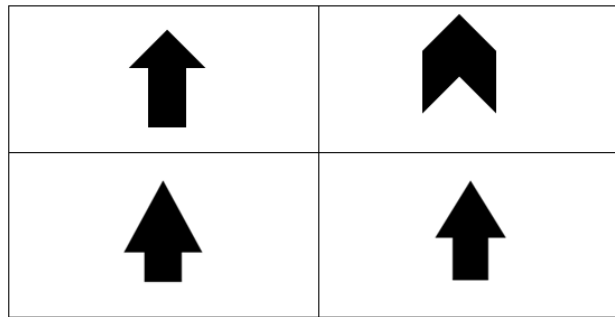
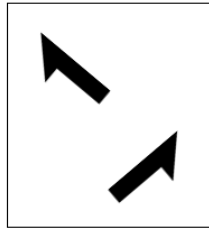

SÉQUENCE 3

FRANÇAIS

Exercise 10

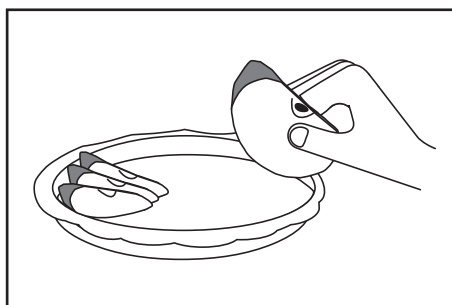
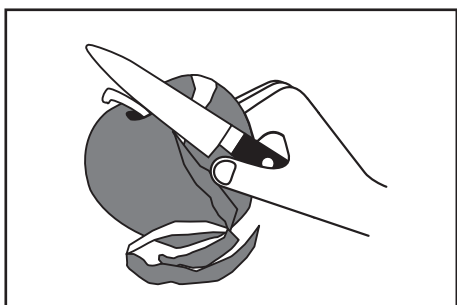
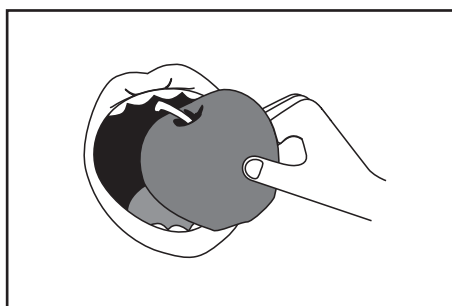
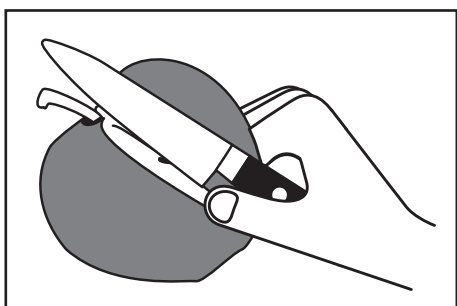
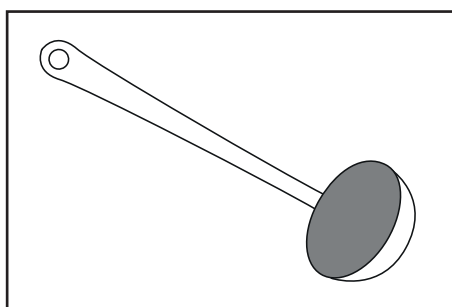
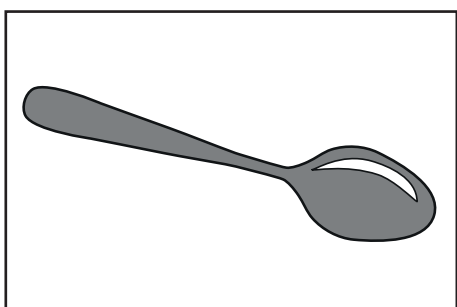
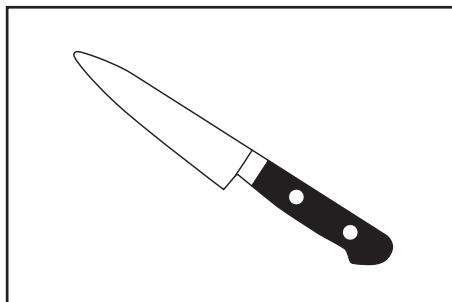
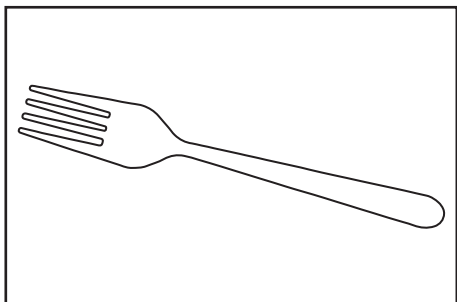

Exercice 10 (suite)

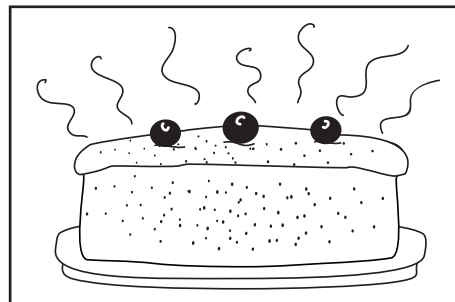
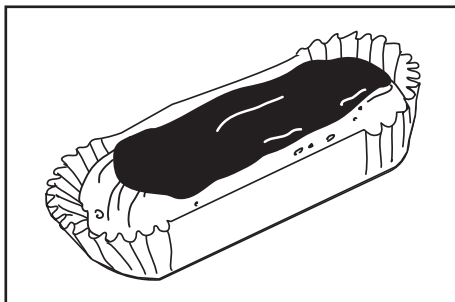
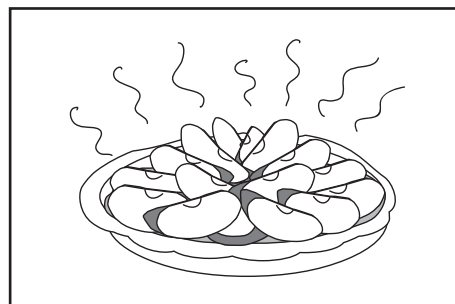
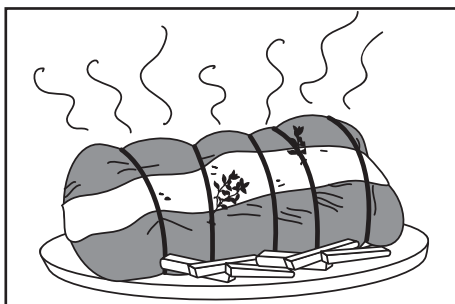
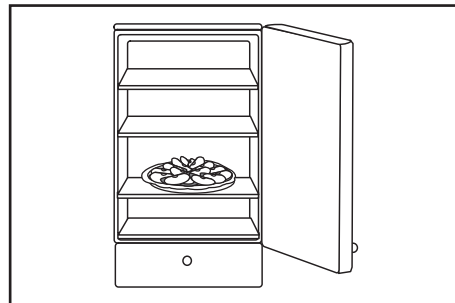
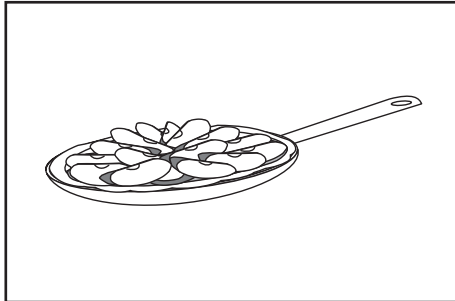

Exercise 11

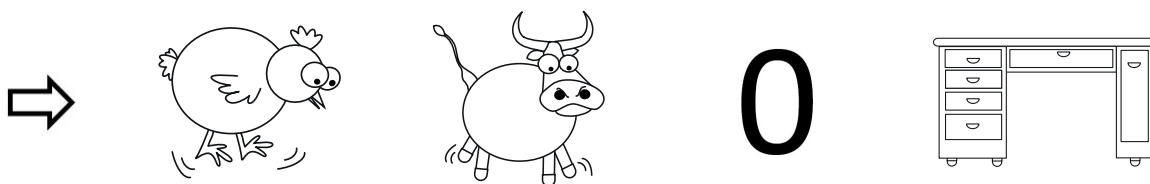
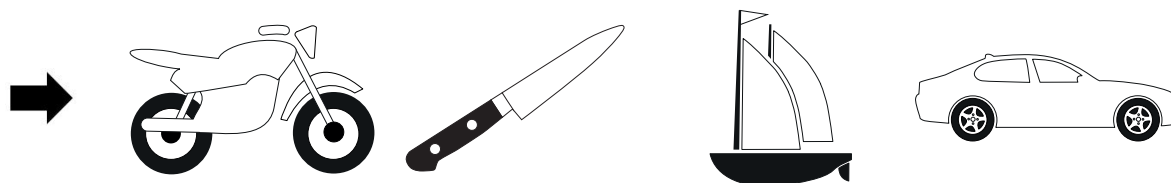
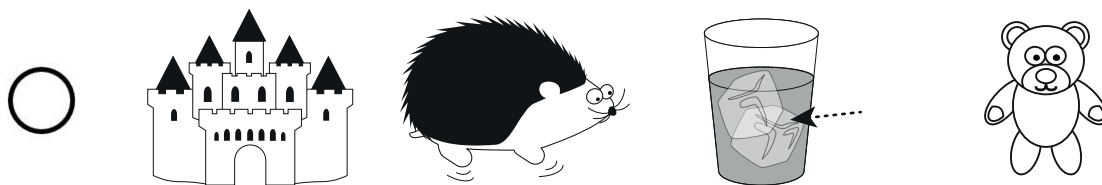
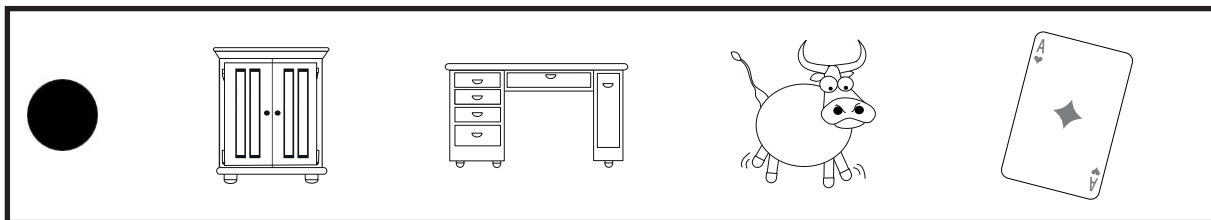

Exercice 11 (suite)

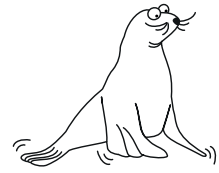
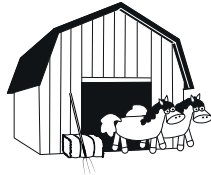
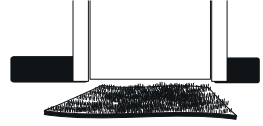
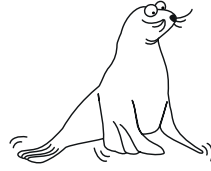
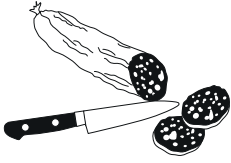

Exercise 12

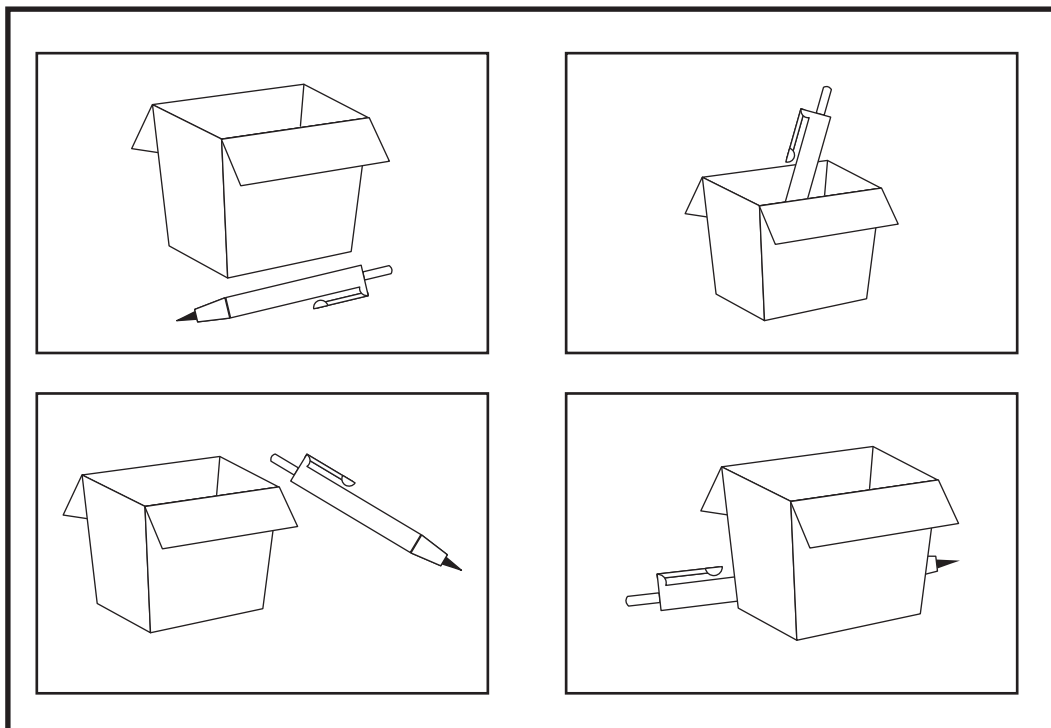
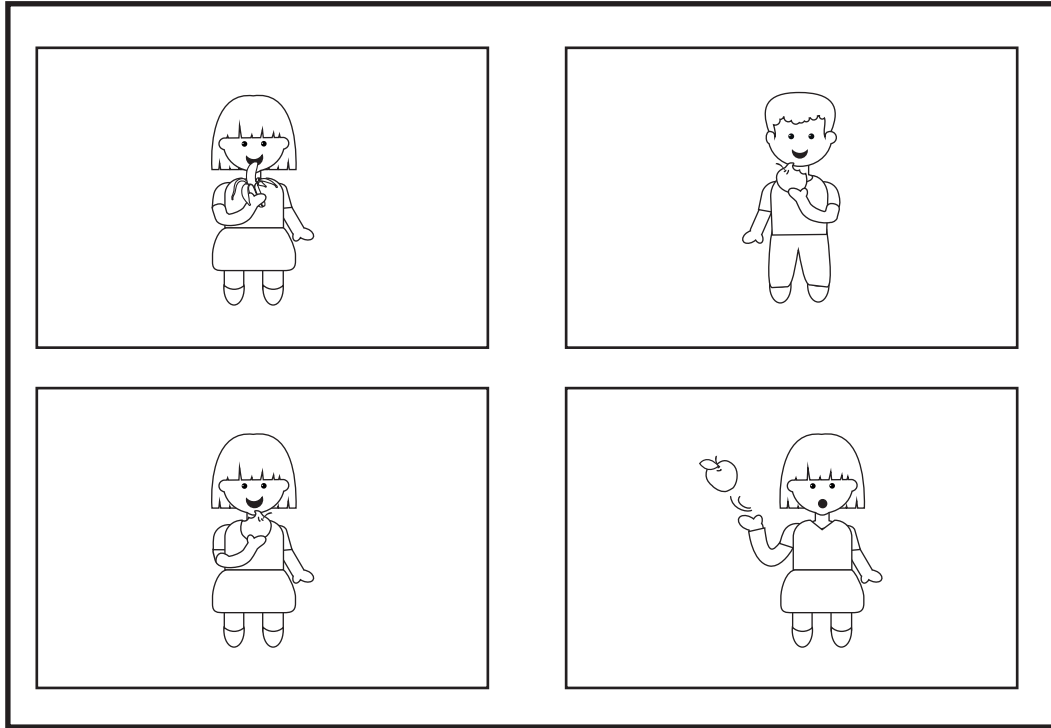

Exercice 12 (suite)

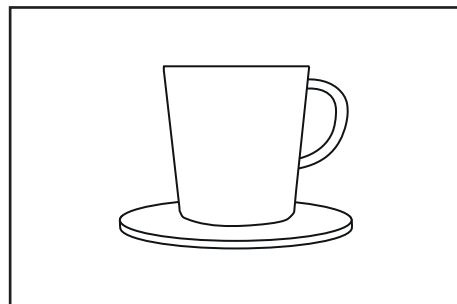
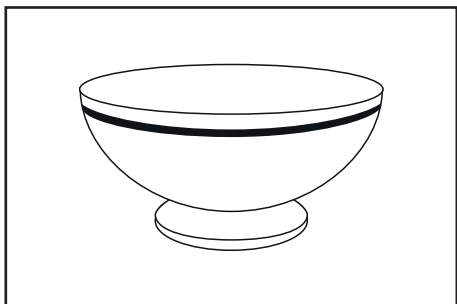
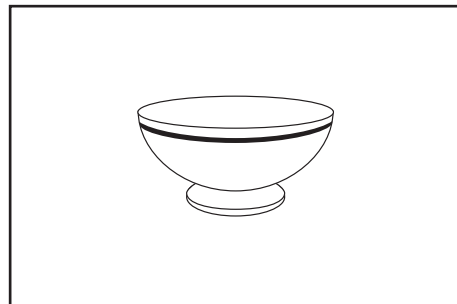
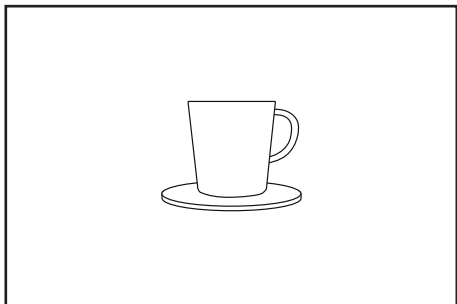
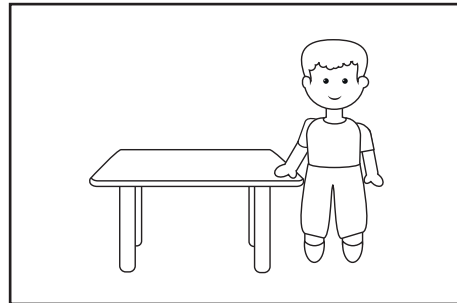
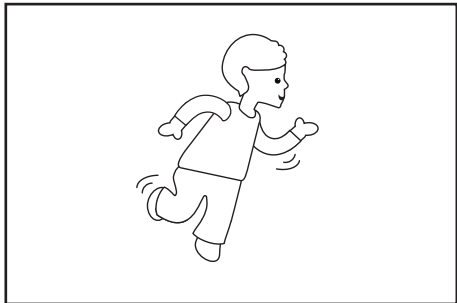
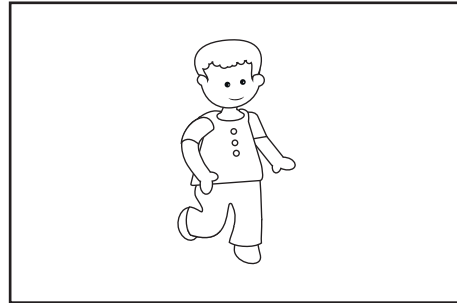
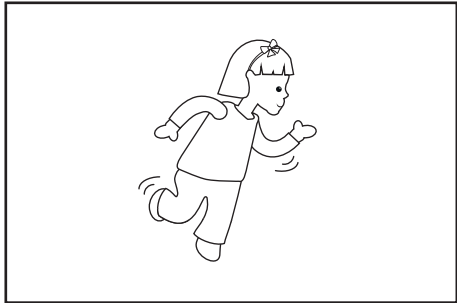

Exercice 12 (suite)

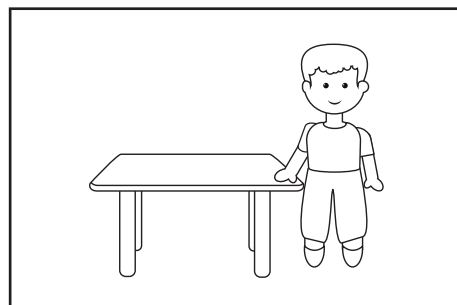
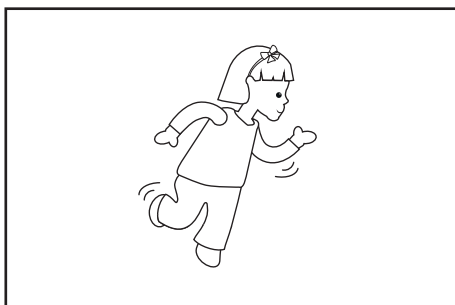
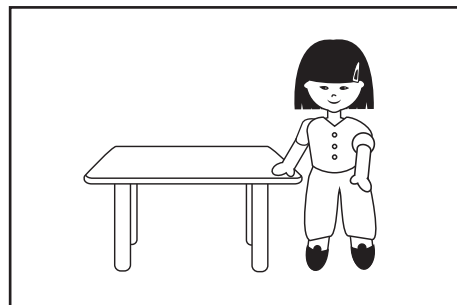
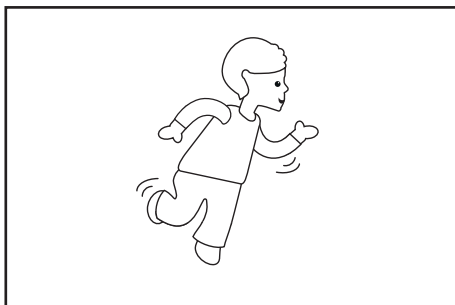
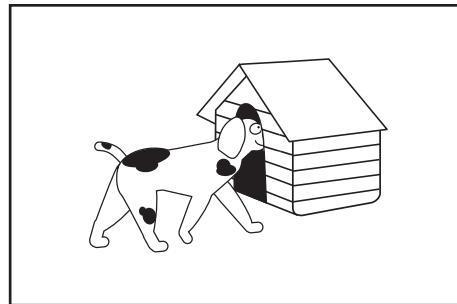
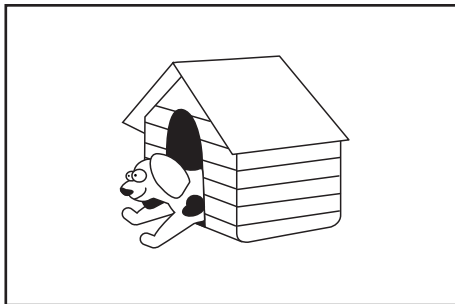
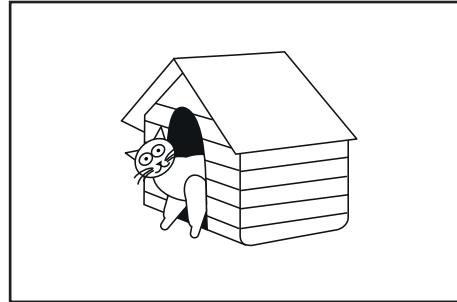
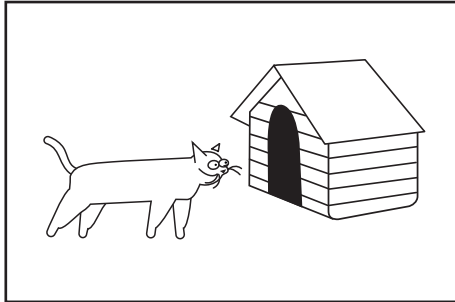

Exercice 12 (suite)

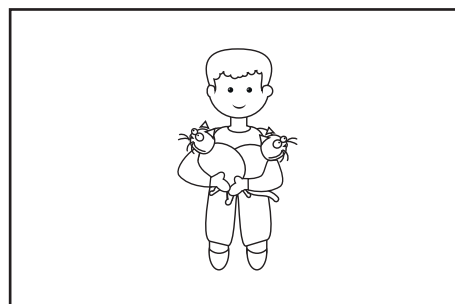
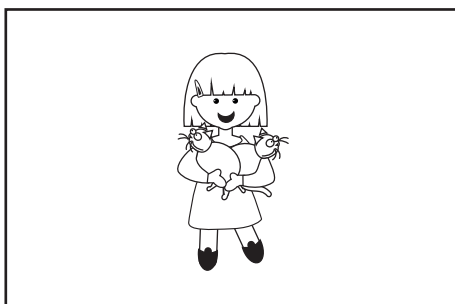
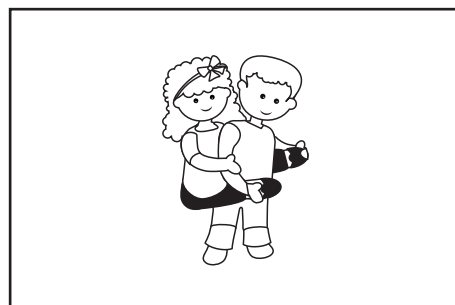
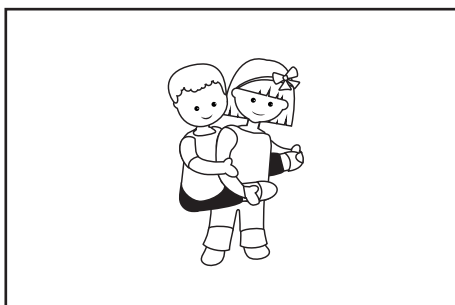
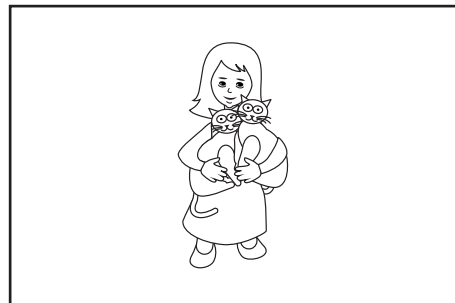
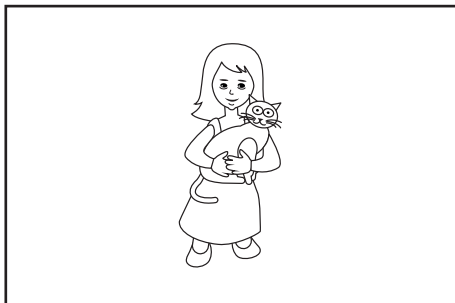
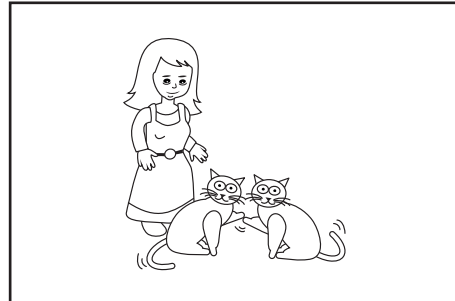
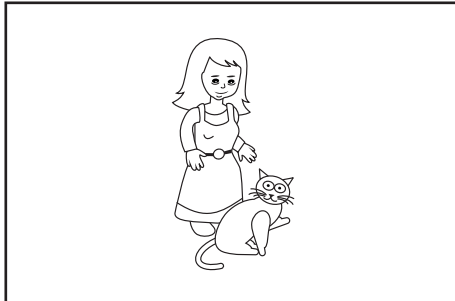

Exercice 12 (suite)

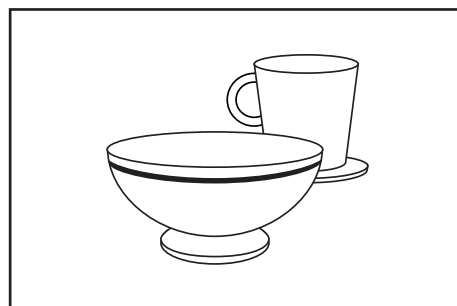
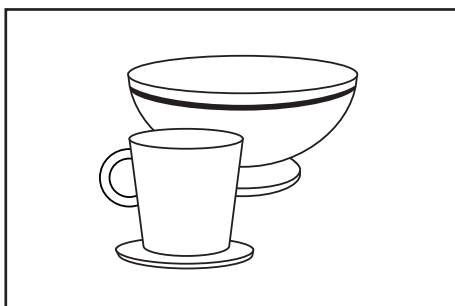
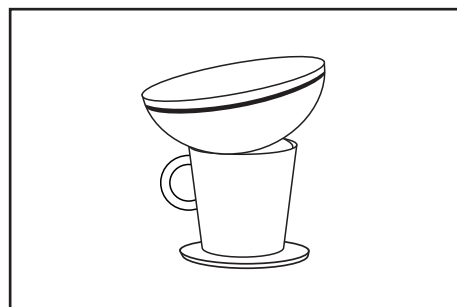
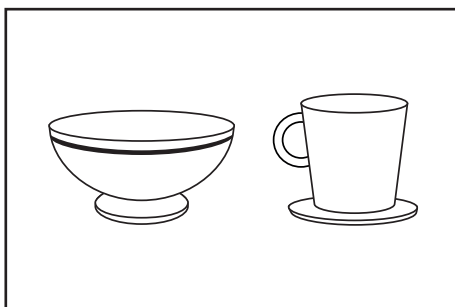
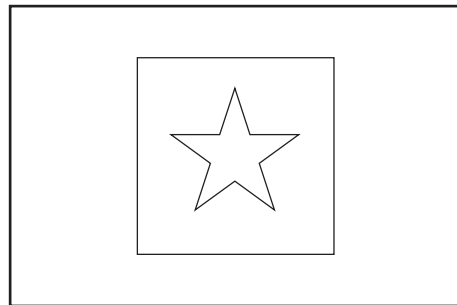
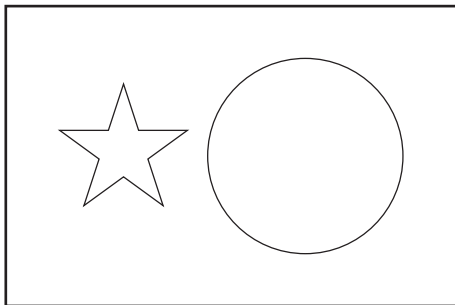
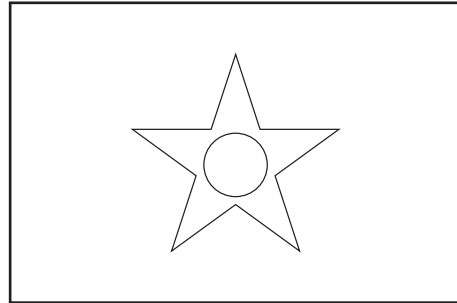
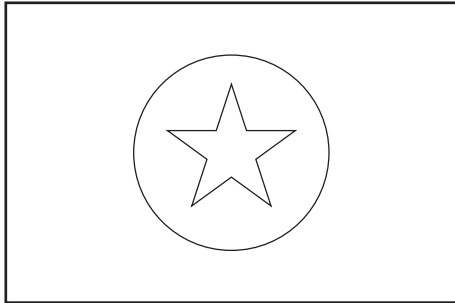

Exercice 12 (suite)

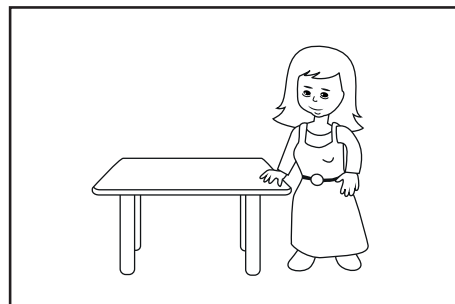
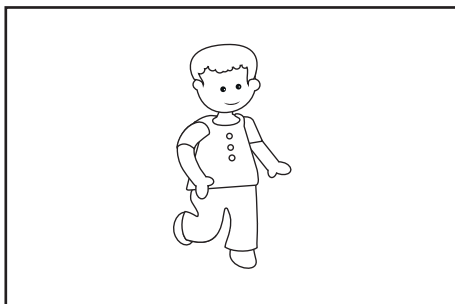
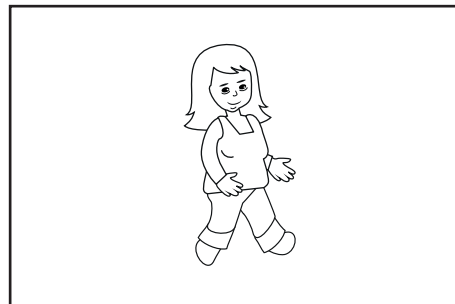
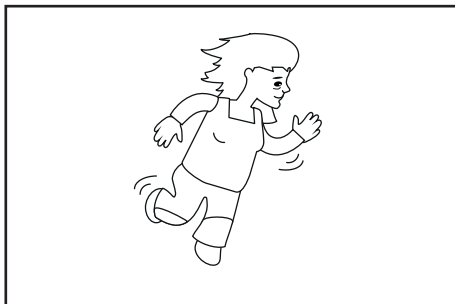
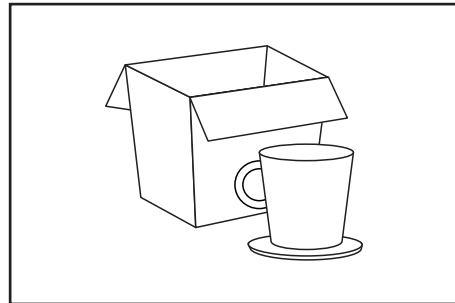
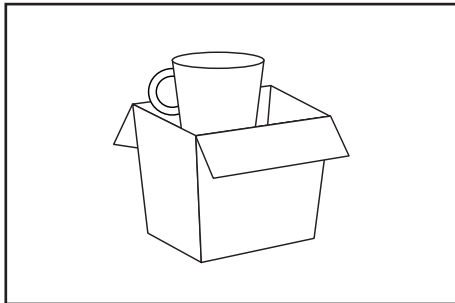
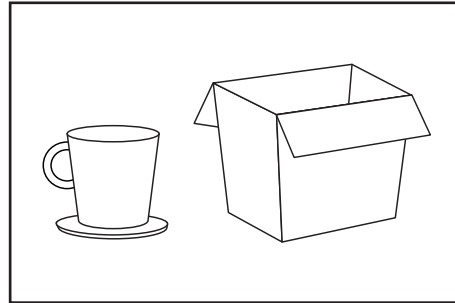
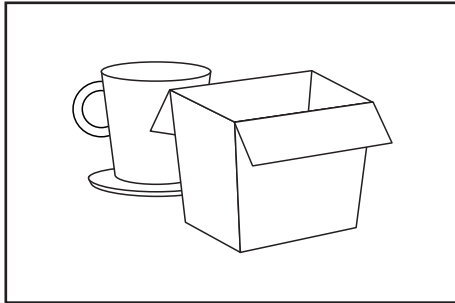

Exercice 12 (suite)

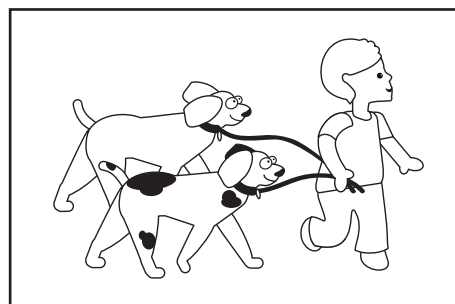
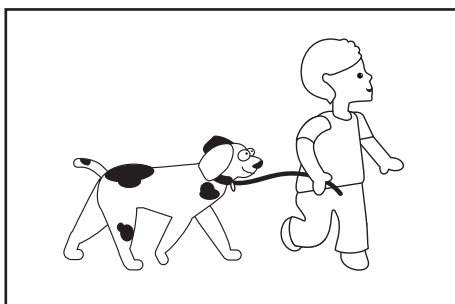
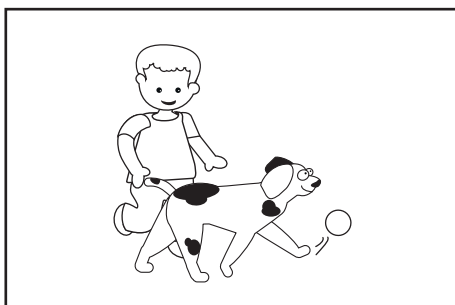
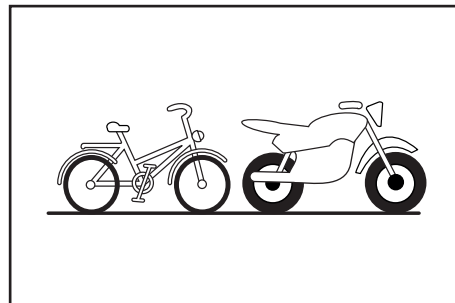
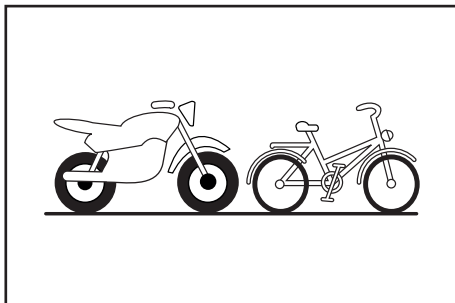
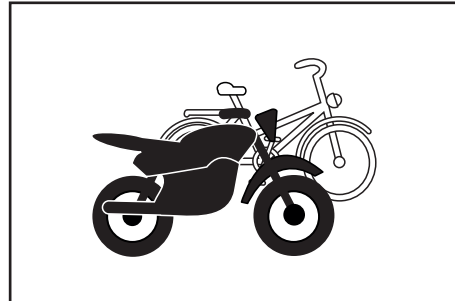
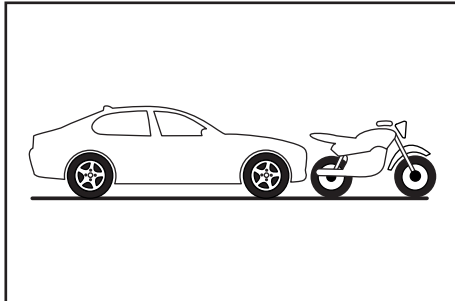

Exercice 12 (suite)

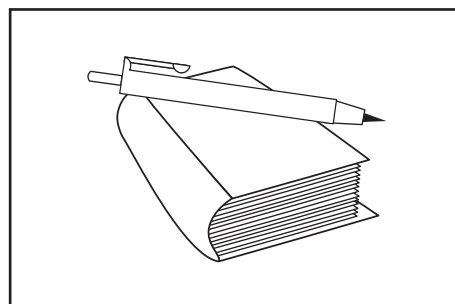
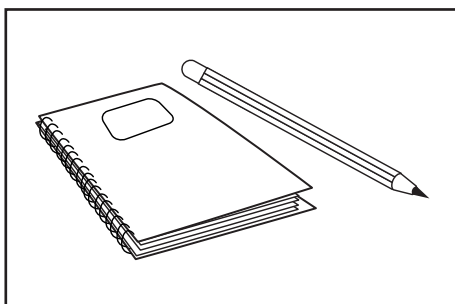
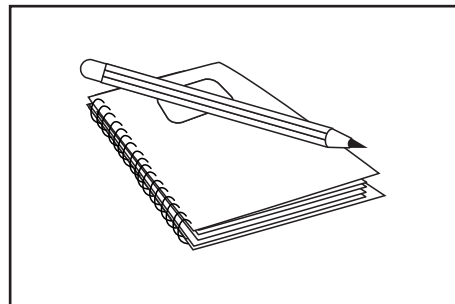
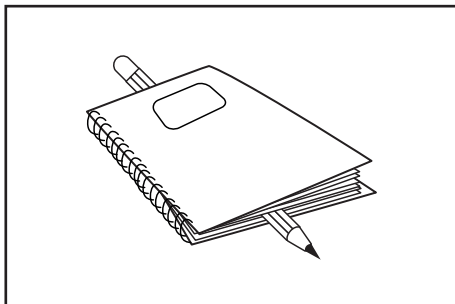
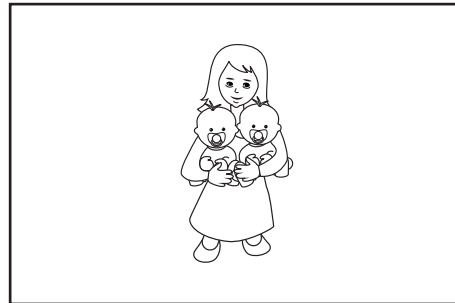
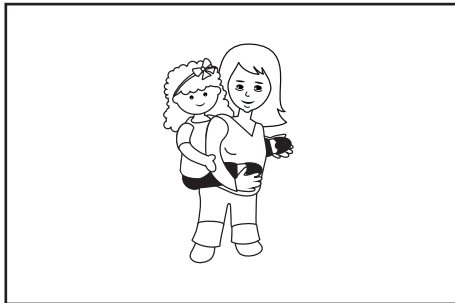
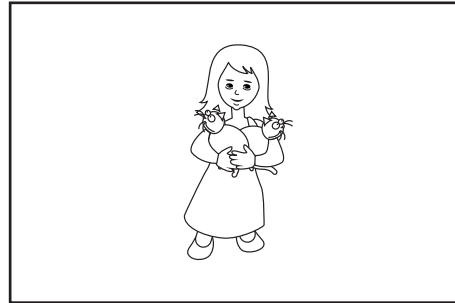
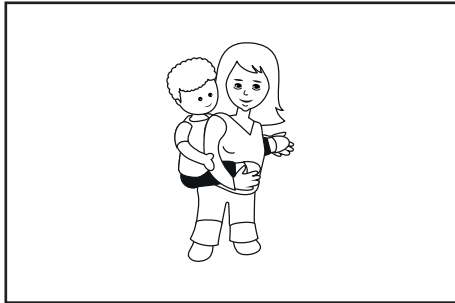

SÉQUENCE 4

MATHÉMATIQUES

Exercise 13

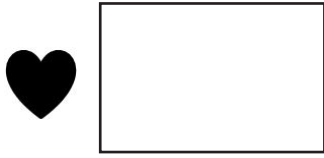
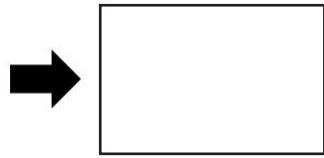
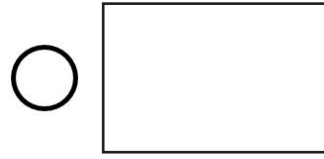

Exercise 14

--	--	--	--	--	--	--

1 2 3 4 5 6

--	--	--	--	--	--	--

1 2 3 4 5 6

Exercice 14 (suite)



1 2 3 4 5 6



1 2 3 4 5 6

Exercise 15

A number line is shown with a scale from 0 to 10. Major tick marks are at 0 and 10. There are 10 smaller tick marks between 0 and 10, representing increments of 1. A diamond-shaped box containing a number is positioned above the second tick mark from 0, with an arrow pointing down to it. A solid black circle is located in the top-left corner of the diagram's frame.

4 8 6 5 2 1

A number line is shown with a scale from 0 to 10. Major tick marks are at 0 and 10. There are 10 smaller tick marks between 0 and 10, representing increments of 1. A diamond-shaped box containing a number is positioned above the fifth tick mark from 0, with an arrow pointing down to it.

3 1 8 9 5 2

Exercice 15 (suite)

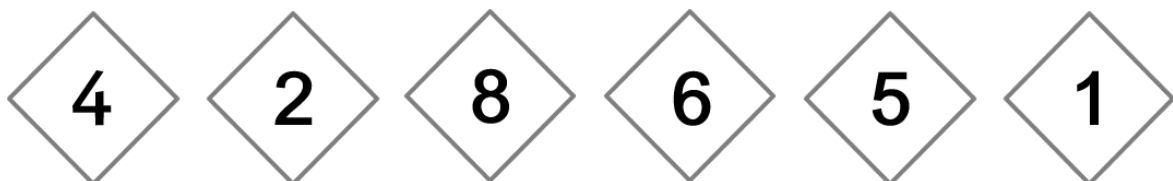
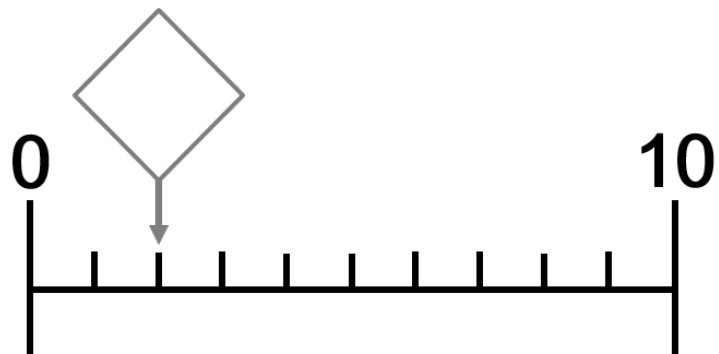
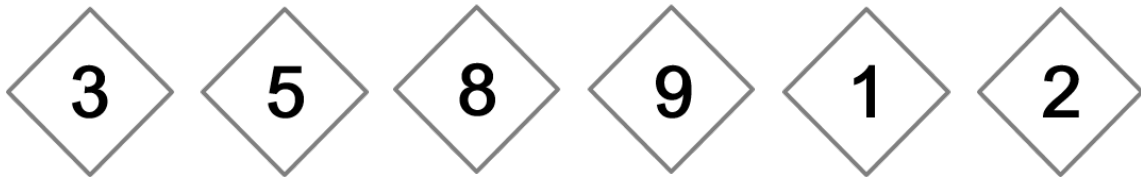
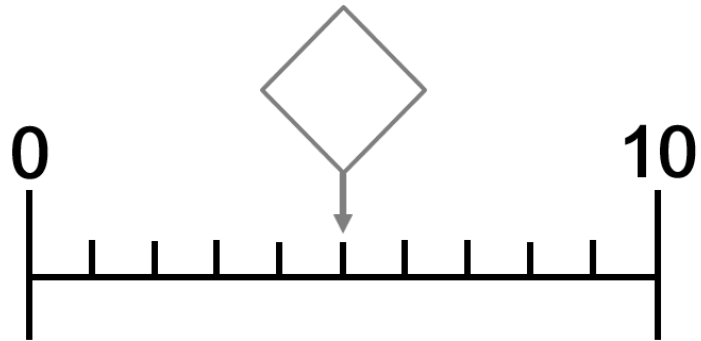

Exercice 15 (suite)

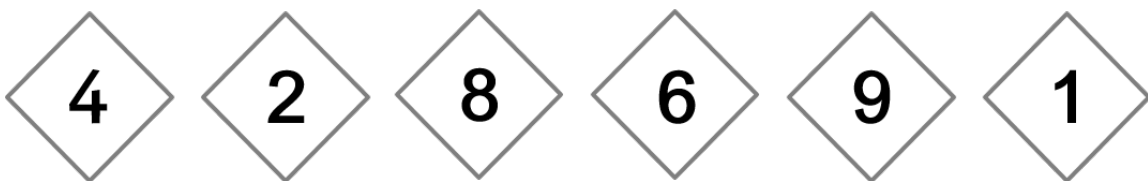
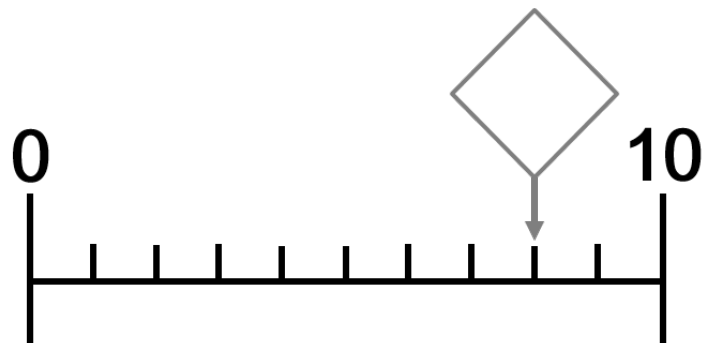
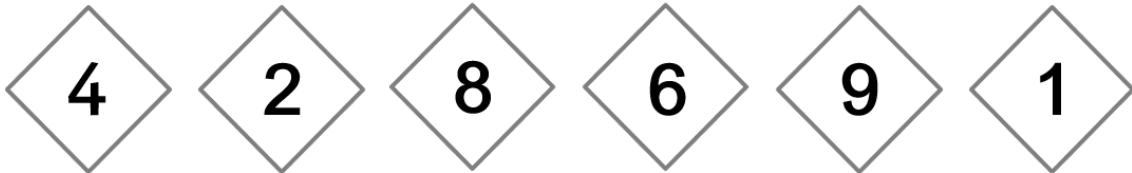
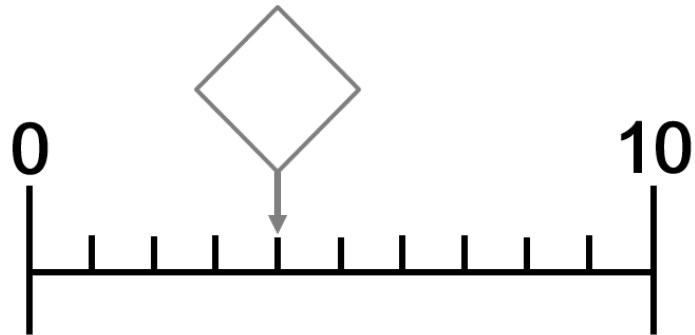

Exercice 15 (suite)

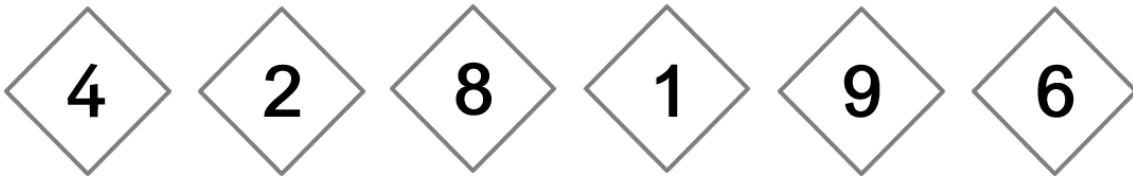
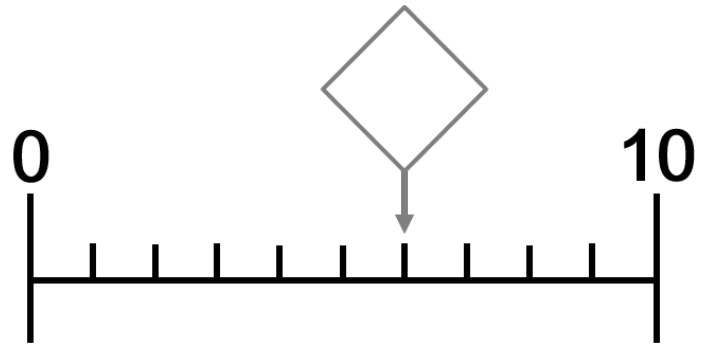

SÉQUENCE 5

FRANÇAIS

Exercise 16

● m n b d f

○ s r p t f

➔ m s r b d

➞ m b d f j

■ l t d h f

Exercice 16 (suite)

 m b d f n

 h l v b d

 n m r t v

 n m r t s

 n d t s f

 n m v u f

Exercise 17

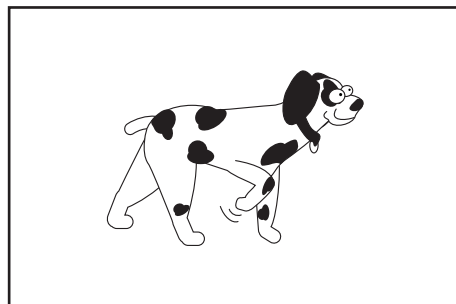
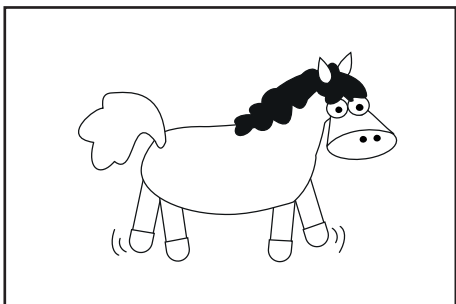
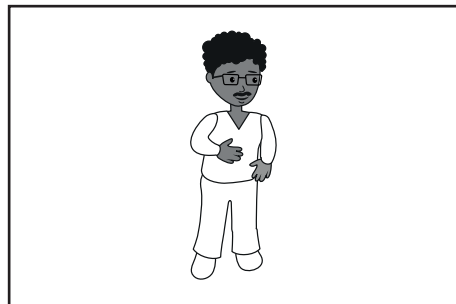
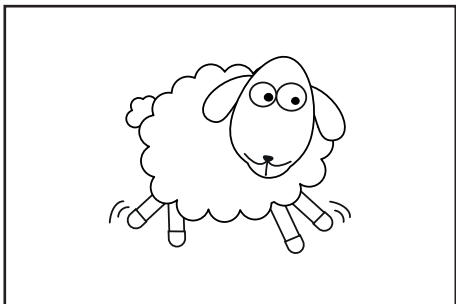
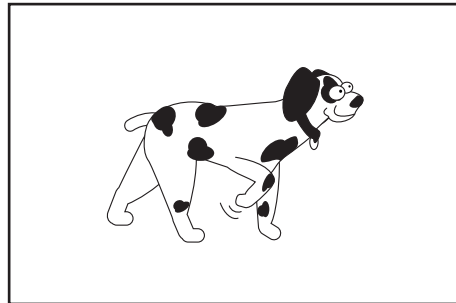
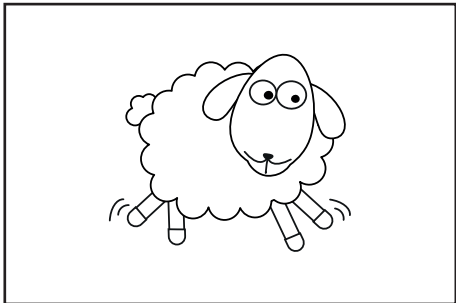
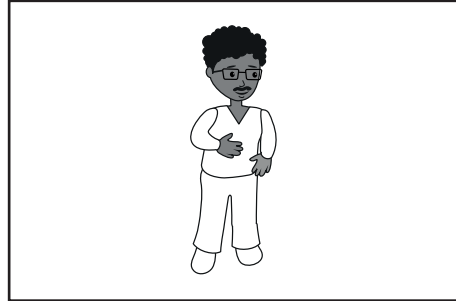
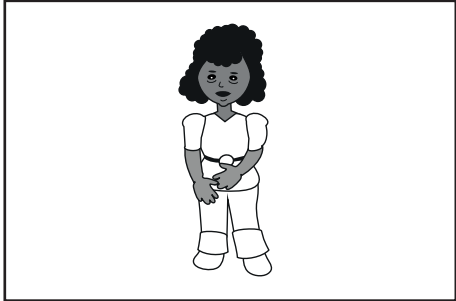

Exercice 17 (suite)

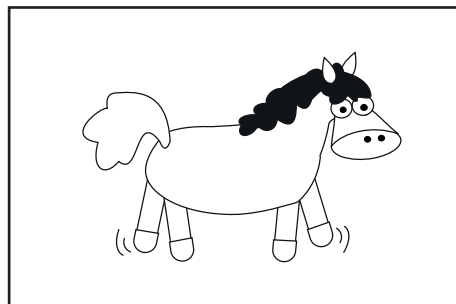
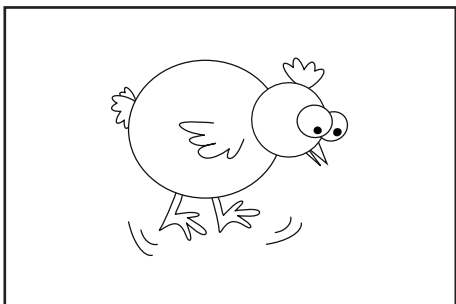
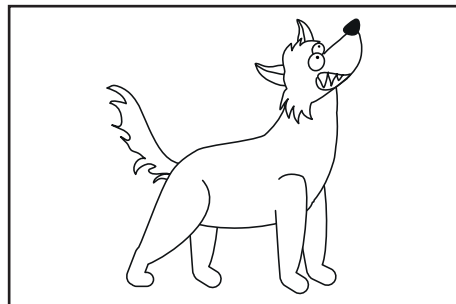
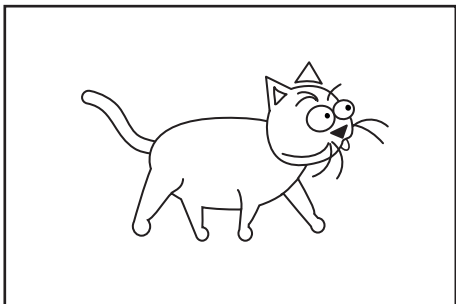
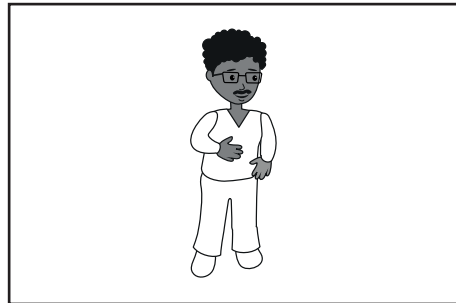
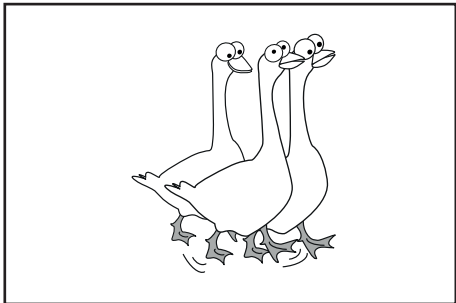
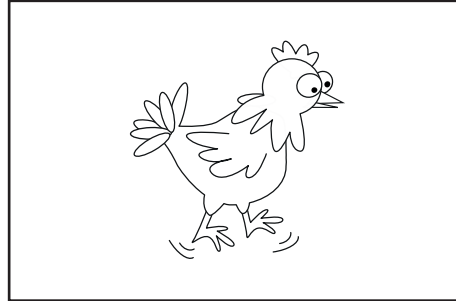
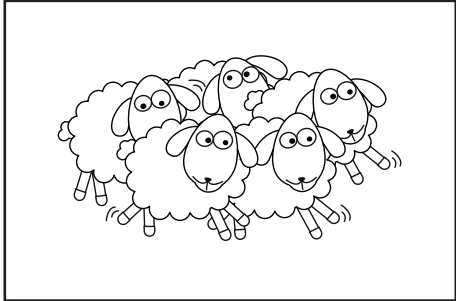

Exercice 18

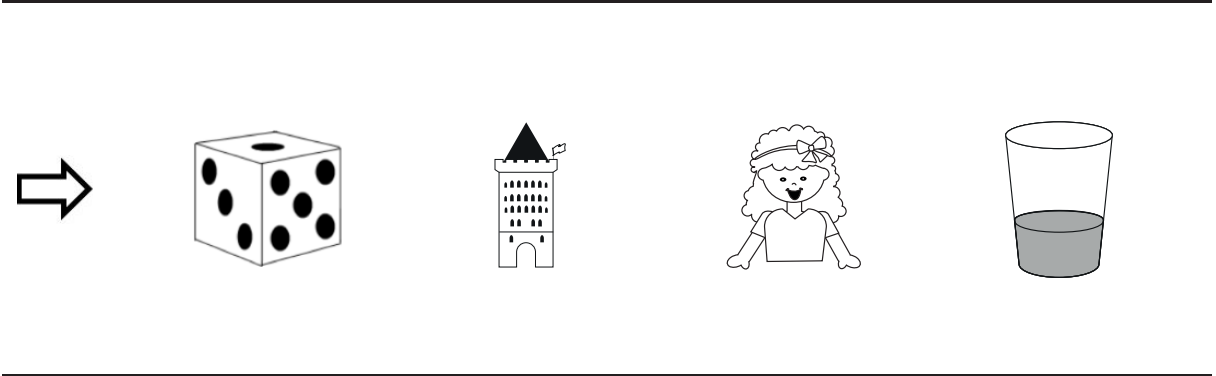
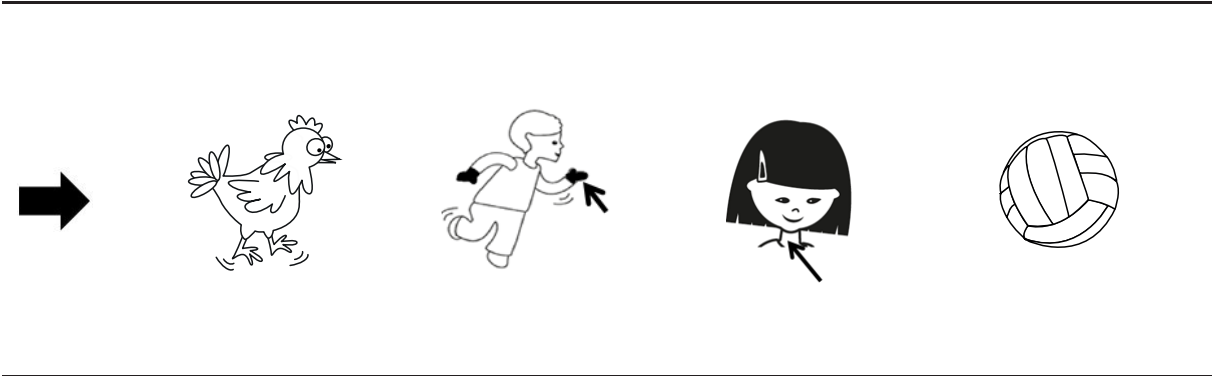
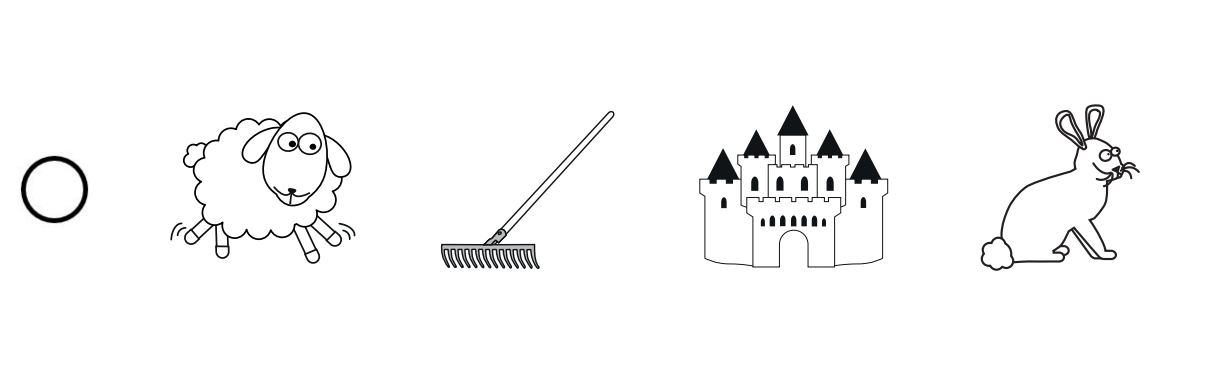
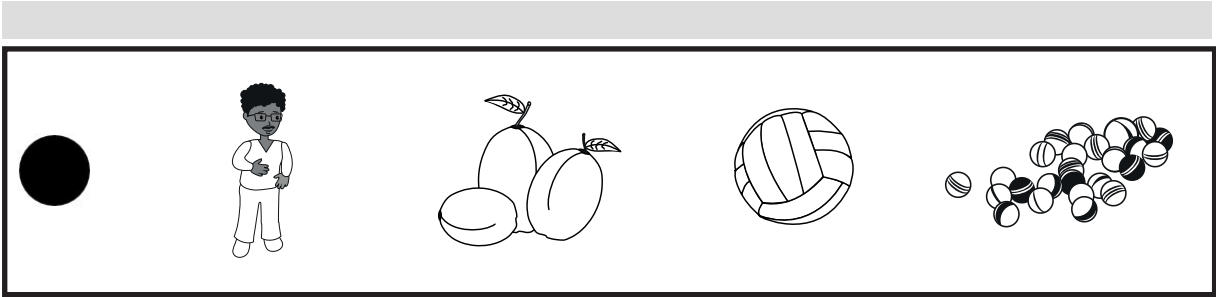

Exercice 18 (suite)

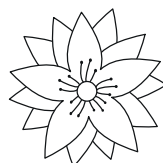
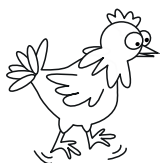
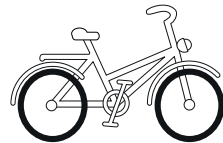
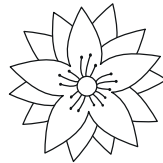
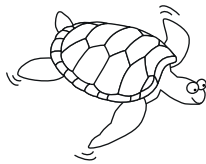
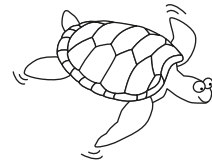
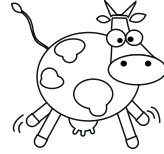
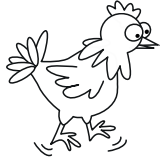

Exercice 19

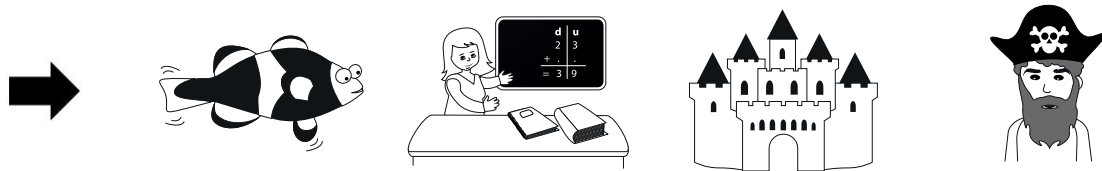
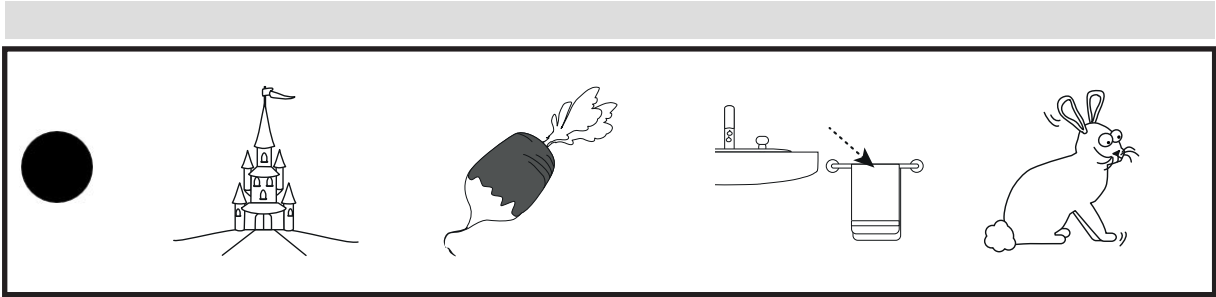

Exercice 19 (suite)

